



ST. ANNE'S COLLEGE OF ENGINEERING AND TECHNOLOGY

(Approved by AICTE, New Delhi. Affiliated to Anna University, Chennai)

ANGUCHETYPALAYAM, PANRUTI – 607 106.

LIST OF PAID SOFTWARE



LIST OF PAID SOFTWARE

S. No.	NAME OF THE SOFTWARE
Department of CSE	
1.	Oracle
2.	Rational Rose
3.	Visual Studio
4.	Server 2008
5.	Windows 10
6.	VIRT Sim
Department Of ECE	
1.	Matlab 10
2.	Xilinx Ise 12.1
3.	Tanner 16.0
4.	Orcad 16.0
Department Of EEE	
1.	Mi Power 10
2.	Matlab
3.	PV Emulator Software
Department Of MECH	
1.	Creo 2.0 / Pro-E
2.	Ansys 13.0
3.	Iron Cad
4.	Edge Cam 2011 Version
5.	CNC Trainer Version 8.01 (OfflineSimulation)
6.	Fluid Sim



ST. ANNE'S COLLEGE OF ENGINEERING AND TECHNOLOGY

(Approved by AICTE, New Delhi. Affiliated to Anna University, Chennai)
ANGUCHETTPALAYAM, PANRUTI – 607 106.

LIST OF OPEN SOURCE SOFTWARE



LIST OF OPEN SOURCE SOFTWARE

S. NO.	NAME OF THE SOFTWARE
1	Ansys HFSS-2015
2	Proteus 8
3	Multisim 8.0
4	E-Sim 2.3
5	Scilab 6.1.1
6	Arduino IDE 2.0
7	MASM For 8086
8	Keil IDEV3.0 & 4.0
9	Python
10	Flash Magic
11	8085 Simulator
12	Python
13	C++
14	Java
15	Eclipse ADK
16	Linux OS
17	Anaconda Navigator
18	Pandas
19	Matpolib
20	Open Nebula
21	Ubuntu OS
22	Virtual Box
23	Hadoop
24	Globus Tool Kit
25	Andriod Studio
26	Netbeans
27	Xamp/Wamp Server
28	N-Stalker
29	Rootkit Hunter



ST. ANNE'S COLLEGE OF ENGINEERING AND TECHNOLOGY
(Approved by AICTE, New Delhi. Affiliated to Anna University, Chennai)
ANGUCHETYPALAYAM, PANRUTI – 607 106.

SCREENSHOT OF SOFTWARES



ST. ANNE'S COLLEGE OF ENGINEERING AND TECHNOLOGY

(Approved by AICTE, New Delhi. Affiliated to Anna University, Chennai)
ANGUCHETTYPALAYAM, PANRUTI – 607 106.

SCREENSHOTS OF SOFTWARE

S.NO	CONTENT
1.	Department of CSE
2.	Department of ECE
3.	Department of EEE
4.	Department of MECHANICAL ENGG



ST. ANNE'S COLLEGE OF ENGINEERING AND TECHNOLOGY
(Approved by AICTE, New Delhi. Affiliated to Anna University, Chennai)
ANGUCHETTYPALAYAM, PANRUTI – 607 106.

DEPARTMENT OF CSE



ST. ANNE'S COLLEGE OF ENGINEERING AND TECHNOLOGY

(Approved by AICTE, New Delhi. Affiliated to Anna University, Chennai)
ANGUCHETTYPALAYAM, PANRUTI – 607 106.

DEVELOPING SOFTWARES



ST. ANNE'S COLLEGE OF ENGINEERING AND TECHNOLOGY

(Approved by AICTE, New Delhi. Affiliated to Anna University, Chennai)
ANGUCHETTPALAYAM, PANRUTI - 607 106.

1. Python:

```
Shell - Konsole <2>
[~/test]> ipython
Python 2.2 (#1, Feb 24 2002, 16:21:58)
Type "copyright", "credits" or "license" for more information.

IPython 0.2.10pre18 -- An enhanced Interactive Python.
?      -> Introduction to IPython's features.
?object -> Details about 'object'; object? also works, ?? prints more.
help    -> Python's own help system.
@magic  -> Information about IPython's 'magic' @ functions.

In [1]: ls --color
class.py  error.py*  gplot.py

In [2]: run error.py
Ramp time: 0.0

-----
NameError                                Traceback (most recent call last)

/usr/local/home/fperez/test/error.py
48
49     print 'speedup:', Rtime/RNtime
50
51
52 if __name__ == '__main__': main()
    global __name__ = __main__ , main = <function main>

/usr/local/home/fperez/test/error.py in main()
43     array_num = zeros(size, 'd')
44     for i in xrange(reps):
45         RampNum(array_num, size, 0.0, 1.0)
    global RampNum = <function RampNum>, array_num = array([ 0.,  0.,  0.,  0.,  0.,  0.,  0.,  0.,  0.,  0.]), size = 10
46     RNtime = time.clock()-t0
47     print 'RampNum time:', RNtime

/usr/local/home/fperez/test/error.py in RampNum(result=array([ 0.,  0.,  0.,  0.,  0.,  0.,  0.,  0.,  0.,  0.]), size=10, start=0.0, end=1.0)
27
28 def RampNum(result, size, start, end):
29     step = (ends-start)/(size-1)
    step = undefined, global ends = undefined, start = 0.0, size = 10
30     result[:] = arange(size)*step + start
31

NameError: global name 'ends' is not defined
WARNING: Failure executing file: 'error.py'

In [3]:
```



ST. ANNE'S COLLEGE OF ENGINEERING AND TECHNOLOGY

(Approved by AICTE, New Delhi. Affiliated to Anna University, Chennai)
ANGUCHETTYPALAYAM, PANRUTI - 607 106.

2.C++: / C

```
File Edit Search Run Compile Debug Project Options Window Help
NONAME00.CPP
#include <iostream.h>
#include <conio.h>
void main()
clrscr();
cout<< "Welcome to C++ Programming ";
getch();
}
```

7:4

F1 Help Alt-F8 Next Msg Alt-F7 Prev Msg Alt-F9 Compile F9 Make F10 Menu



ST. ANNE'S COLLEGE OF ENGINEERING AND TECHNOLOGY

(Approved by AICTE, New Delhi. Affiliated to Anna University, Chennai)

ANGUCHETTYPALAYAM, PANRUTI – 607 106.

3.Java:

```
RandomInteger.java
import java.util.Random;

public class RandomInteger {
    public static void main(String[] args) {
        log("Generating 10 random integers in range 0..99");

        Random randomGenerator = new Random();
        for (int i = 0; i < 10; i++) {
            int random = randomGenerator.nextInt(100);
            log("Generated: " + random);
        }

        log("Done");
    }

    private static void log(String message) {
        System.out.println(message);
    }
}
```



ST. ANNE'S COLLEGE OF ENGINEERING AND TECHNOLOGY

(Approved by AICTE, New Delhi. Affiliated to Anna University, Chennai)
ANGUCHETTYPALAYAM, PANRUTI – 607 106.

4.Eclipse ADK:

The screenshot displays the Eclipse IDE interface. The main editor shows the source code for `MultiPageContributor.java`. The code includes package declarations, imports, and a class definition that extends `MultiPageContributor`. The class has a constructor and a `getAction` method. The IDE also shows a Package Explorer on the left, a Problems view at the bottom, and a documentation window on the right.

```
20 * Copyright (c) 2000, 2005 IBM Corporation and other
11 package org.eclipse.ui.examples.multipageeditor;
12
13 import org.eclipse.jface.action.IAction;
14
15 /**
16  * SOFTPEDIA TEST
17  * WWW.SOFTPEDIA.COM
18  * Manages the installation/deinstallation of global actions.
19  * Responsible for the redirection of global actions.
20  * Multi-page contributor replaces the contributors.
21  */
22 public class MultiPageContributor extends MultiPageContributor {
23     private IEditorPart activeEditorPart;
24
25     /**
26      * Creates a multi-page contributor.
27      */
28     public MultiPageContributor() {
29         super();
30     }
31
32     /**
33      * Returns the action registered with the given editor.
34      * @return IAction or null if editor is null.
35      */
36     protected IAction getAction(IEditorPart editor, String id) {
37         // ...
38     }
39 }
40
41
42
```

Multi-page Editor

The Multi Page Editor Example adds an editor for files with the .mpe extension. It shows how to create an editor that uses multiple pages by defining both an editor and a page contributor that can add entries to an action bar.

[Read More](#)

What you can do with the sample

- [Browse the source code](#) in the workspace.
- When ready, [run the sample](#) and follow instructions in the [help document](#).
- Later on, you can re-run the sample by pressing the **Run** icon on the tool bar.
- If you place breakpoints in the code, you can [debug it](#).
- Later on, you can debug the sample by pressing the **Debug** icon on the tool bar.

Description	Resource	Path	Location
> 3 Errors (3 items)			
> 3 Warnings (3 items)			

Writable Smart Insert 23:21



ST. ANNE'S COLLEGE OF ENGINEERING AND TECHNOLOGY

(Approved by AICTE, New Delhi. Affiliated to Anna University, Chennai)
ANGUCHETTYPALAYAM, PANRUTI – 607 106.

5. Anaconda Navigator :





ST. ANNE'S COLLEGE OF ENGINEERING AND TECHNOLOGY

(Approved by AICTE, New Delhi. Affiliated to Anna University, Chennai)
ANGUCHETTYPALAYAM, PANRUTI – 607 106.

6.Pandas:

```
In [38]: import pandas as pd

one = pd.DataFrame({
    'Name': ['Amber', 'Jack', 'Brown', 'Smith', 'Young'],
    'subject_id': ['sub1', 'sub2', 'sub4', 'sub6', 'sub5'],
    'Marks_scored': [93, 90, 82, 64, 71]},
    index=[1, 2, 3, 4, 5])

two = pd.DataFrame({
    'Name': ['Ben', 'Cole', 'Sam', 'Tom', 'Martial'],
    'subject_id': ['sub2', 'sub4', 'sub3', 'sub6', 'sub5'],
    'Marks_scored': [96, 80, 73, 77, 81]},
    index=[1, 2, 3, 4, 5])
print (pd.concat([one, two]))
```

	Name	subject_id	Marks_scored
1	Amber	sub1	93
2	Jack	sub2	90
3	Brown	sub4	82
4	Smith	sub6	64
5	Young	sub5	71
1	Ben	sub2	96
2	Cole	sub4	80
3	Sam	sub3	73
4	Tom	sub6	77
5	Martial	sub5	81



ST. ANNE'S COLLEGE OF ENGINEERING AND TECHNOLOGY

(Approved by AICTE, New Delhi. Affiliated to Anna University, Chennai)
ANGUCHETTYPALAYAM, PANRUTI - 607 106.

7. Matplotlib lib:

```
from matplotlib import pyplot as plt
```

```
x = [3, 6, 9]
```

```
y = [2, 4, 6]
```

```
plt.plot(x, y)
```

```
plt.show()
```

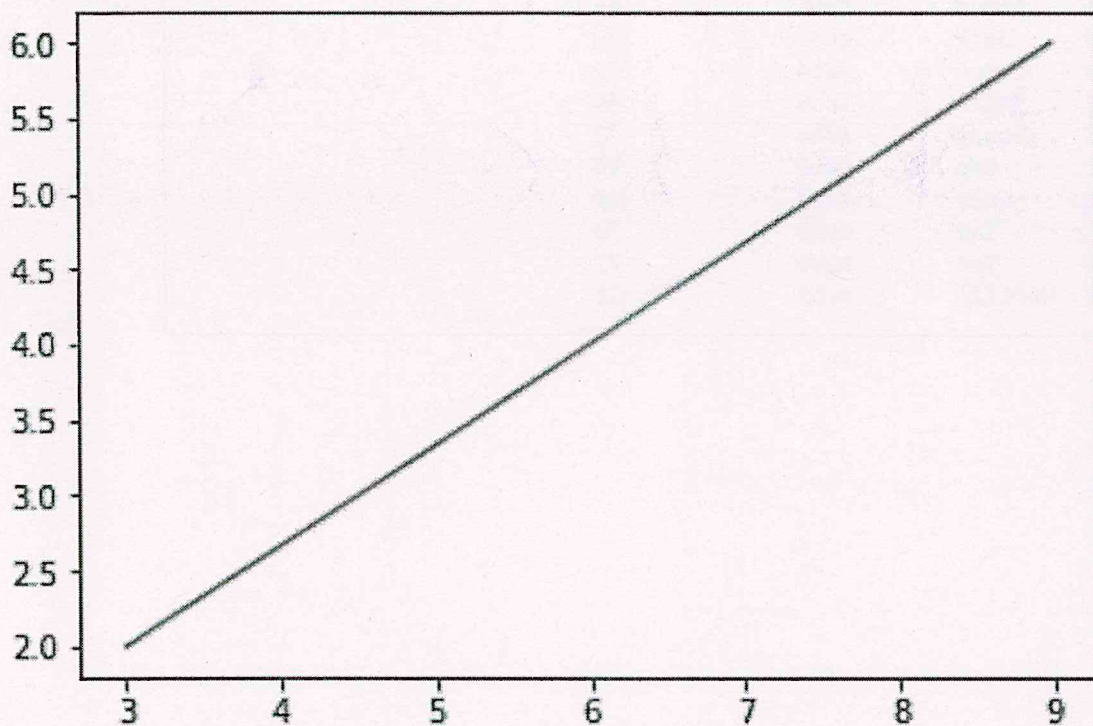



ST. ANNE'S COLLEGE OF ENGINEERING AND TECHNOLOGY

(Approved by AICTE, New Delhi. Affiliated to Anna University, Chennai)
ANGUCHETTYPALAYAM, PANRUTI – 607 106.

8.Word Press:

The screenshot displays the WordPress dashboard for a user named 'Economics'. The interface includes a sidebar menu with options like Dashboard, Home, Updates, Posts, Media, Pages, Photo Gallery, Comments, Testimonials, Our Team, Appearance, Plugins, Users, Tools, Settings, and Collapse menu. The main content area features several widgets:

- At a Glance:** Shows 5 Posts, 20 Pages, and 2 Comments. It also indicates that WordPress 4.8.2 is running on a Multipurpose theme and that search engines are discouraged.
- Quick Draft:** A form for creating a new draft, including fields for Title and content, and a Save Draft button.
- Activity:** A list of recently published posts with their dates and times, such as 'Post For learn Education' and 'Hello world!'.
- Recent Comments:** A list of comments, including one from 'admin' and another from 'Mr WordPress'.
- WordPress Events and News:** A section for upcoming events, such as 'Global WordPress Translation Day - #GWTD3' in Nagpur, India.



ST. ANNE'S COLLEGE OF ENGINEERING AND TECHNOLOGY

(Approved by AICTE, New Delhi. Affiliated to Anna University, Chennai)
ANGUCHETTYPALAYAM, PANRUTI – 607 106.

9. Flutter Tool:

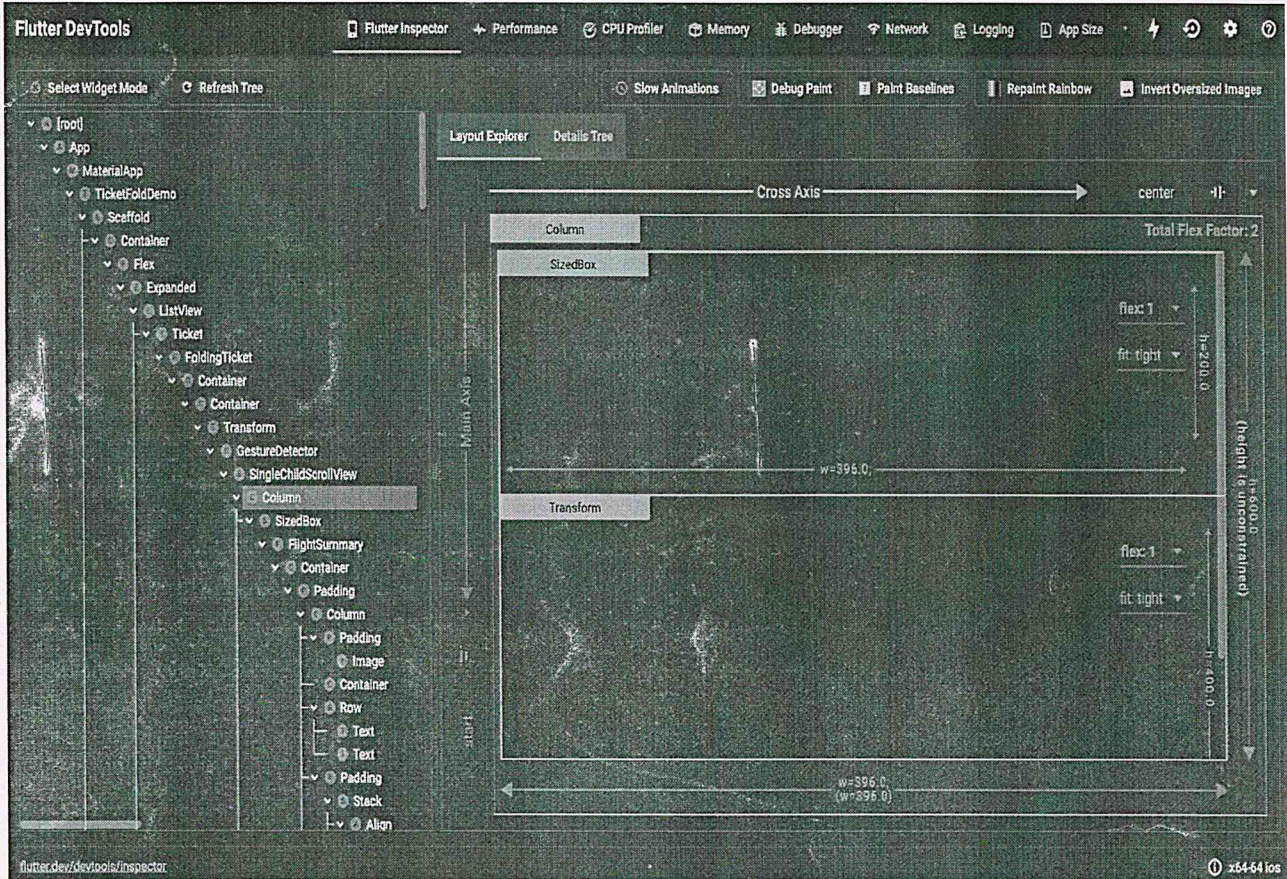



ST. ANNE'S COLLEGE OF ENGINEERING AND TECHNOLOGY

(Approved by AICTE, New Delhi. Affiliated to Anna University, Chennai)

ANGUCHETTYPALAYAM, PANRUTI – 607 106.

SYSTEM SOFTWARES



ST. ANNE'S COLLEGE OF ENGINEERING AND TECHNOLOGY

(Approved by AICTE, New Delhi. Affiliated to Anna University, Chennai)

ANGUCHETTYPALAYAM, PANRUTI – 607 106.

1.Ubuntu OS:

```
Terminal
ubuntuuser@ubuntu-machine: ~
ubuntuuser@ubuntu-machine:~$ ls
Desktop  Downloads  Music      Public     Sample.ods  Videos
Documents examples.desktop Pictures   Sample.odp  Templates
```



ST. ANNE'S COLLEGE OF ENGINEERING AND TECHNOLOGY

(Approved by AICTE, New Delhi. Affiliated to Anna University, Chennai)
ANGUCHETTYPALAYAM, PANRUTI – 607 106.

2.Linux OS:

```
mark@linux-desktop: /tmp/tutorial
File Edit View Search Terminal Help
mark@linux-desktop:/tmp/tutorial$ mv "folder 1" folder_1
mark@linux-desktop:/tmp/tutorial$ mv "folder 2" folder_2
mark@linux-desktop:/tmp/tutorial$ mv "folder 3" folder_3
mark@linux-desktop:/tmp/tutorial$ mv "folder 4" folder_4
mark@linux-desktop:/tmp/tutorial$ mv "folder 5" folder_5
mark@linux-desktop:/tmp/tutorial$ mv "folder 6" folder_6
mark@linux-desktop:/tmp/tutorial$ ls
another      dir1  folder  folder_3  folder_6
combined_backup.txt  dir2  folder_1  folder_4  output.txt
combined.txt      dir4  folder_2  folder_5
mark@linux-desktop:/tmp/tutorial$ rm dir4/dir5/dir6/combined.txt combined_backup
.txt
mark@linux-desktop:/tmp/tutorial$ rm folder_*
rm: cannot remove 'folder_1': Is a directory
rm: cannot remove 'folder_2': Is a directory
rm: cannot remove 'folder_3': Is a directory
rm: cannot remove 'folder_4': Is a directory
rm: cannot remove 'folder_5': Is a directory
rm: cannot remove 'folder_6': Is a directory
mark@linux-desktop:/tmp/tutorial$
```





ST. ANNE'S COLLEGE OF ENGINEERING AND TECHNOLOGY

(Approved by AICTE, New Delhi. Affiliated to Anna University, Chennai)

ANGUCHETTYPALAYAM, PANRUTI – 607 106.

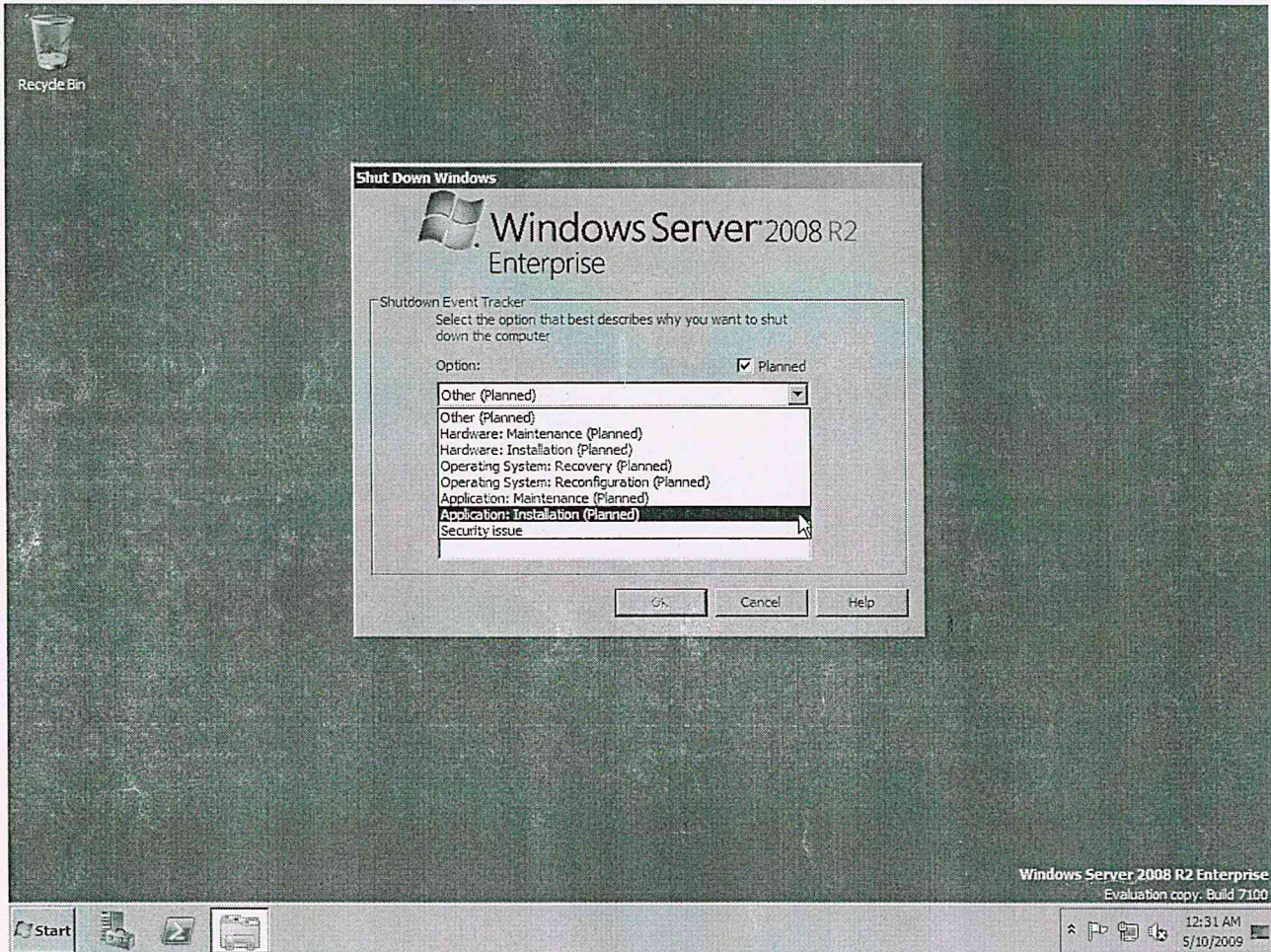
3.Windows Server 2008:



Is it genuine? Verify the Holographic Security thread is interwoven and passes through the holes in the paper. The inside edge of each hole is uniquely shaped from random paper fibers. When viewed from the back, the embedded thread is fully visible only within each hole. For further details, go to www.howtotell.com.

Microsoft Open License Agreement

St. Anne's College of Engineering and Technology
 Siruvathur PO
 Anguchettypalayam, Panruti Taluk

Cuddalore Dist TN
 INDIA

0005002172

Licensee Authorization Number

66870976ZZE1205

License Agreement Number

46851572

Licensee Reference (if any)

Issue Date of the Initial License Agreement	Issue Date of this License Agreement	Last Date for Repeat Orders/ End of Maintenance Coverage
10 May 2010	10 May 2010	31 May 2012
Product Pool	Volume Pricing Level	License Program
Not Applicable	No Level	Educational

Product Description	Microsoft Product Number	Copies Licensed or Version Maintained
---------------------	--------------------------	---------------------------------------

Volume License Product Key Information:			
<u>Product Description</u>	<u>Key Classification</u>	<u>VLK</u>	<u>Key Type</u>
WinSvrStd 2008R2 SNGL OLP NL Acdmc	Win Srv 2008R2 Std/Ent - MAK B	YR72W-9JJWP-76PTV-JM8KX-VM9XX	
WinSvrStd 2008R2 SNGL OLP NL Acdmc	Windows Server 2003 R2, x32 Ed.	D7CW6-RM4TW-MQTMF-YCPYB-C6PM8	VA1.0
WinSvrStd 2008R2 SNGL OLP NL Acdmc	Windows Server 2003 R2, x64 Ed.	WFYTC-FHGJK-D6BGK-B7FYJ-CXG73	VA1.0
WinSvrStd 2008R2 SNGL OLP NL Acdmc	Windows Server 2008 Std/Ent KMS B	DY2G6-HDBXK-BXW2X-92TKC-X74B9	KMS
WinSvrStd 2008R2 SNGL OLP NL Acdmc	Windows Server 2008 Std/Ent MAK B	YB46B-9DQ72-JF2X7-Q8687-DFWH8	
WinSvrStd 2008R2 SNGL OLP NL Acdmc	Windows Server 2008R2 Std/Ent KMS B	BTB67-6WHGR-HMGP4-Y76YJ-PY2WV	KMS

Total quantity for License Agreement Number **46851572 is **31****

Volume License Product Key. To install certain licensed products you will need to use a specific Volume License Product Key (VLK). This VLK is issued to your company for your exclusive use for each specific license purchase. You agree to use your best efforts to keep a secure record of this product key including not disclosing this product key to any unauthorized third party. For more information about Volume License Product Keys and Key Types, go to the "Volume License Product Key" section of <http://www.microsoft.com/licensing>.

Customers who acquire Microsoft Business Solutions software must acquire a Registration Key to enable the software by registering at: <http://www.microsoft.com/BusinessSolutions/MBSRegistration> using their valid license agreement details. Please note this site is for registration of Microsoft Business Solutions (Customer Relationship Management) licenses only.

Is it genuine? Verify the Holographic Security thread is interwoven and passes through the holes in the paper. The inside edge of each hole is uniquely shaped from random paper fibers. When viewed from the back, the embedded thread is fully visible only within each hole. For further details, go to www.howtotell.com.

Microsoft Open License Agreement

St. Anne's College of Engineering and Technology
 Siruvathur PO
 Anguchettypalayam, Panrati Taluk

Cuddalore Dist TN
 INDIA

0005002172

License Authorization Number

66870976ZZE1205

License Agreement Number

46851572

Licensee Reference (if any)

<i>Issue Date of the Initial License Agreement</i>	<i>Issue Date of this License Agreement</i>	<i>Last Date for Repeat Orders/ End of Maintenance Coverage</i>
10 May 2010	10 May 2010	31 May 2012
<i>Product Pool</i>	<i>Volume Pricing Level</i>	<i>License Program</i>
Not Applicable	No Level	Educational

<i>Product Description</i>	<i>Microsoft Product Number</i>	<i>Version</i>	<i>Copies Licensed or Maintained</i>
WinSvrStd 2008R2 SNGL OLP NL Acdmc	P73-04966	2008 R2	**1**
WinSvrCAL 2008 SNGL OLP NL Acdmc DvcCAL	R18-02639	2008	**30**

Total quantity for License Agreement Number **46851572 is **31****

Volume License Product Key. To install certain licensed products you will need to use a specific Volume License Product Key (VLK). This VLK is issued to your company for your exclusive use for each specific license purchase. You agree to use your best efforts to keep a secure record of this product key including not disclosing this product key to any unauthorized third party. For more information about Volume License Product Keys and Key Types, go to the "Volume License Product Key" section of <http://www.microsoft.com/licensing>.

Customers who acquire Microsoft Business Solutions software must acquire a Registration Key to enable the software by registering at: <http://www.microsoft.com/BusinessSolutions/MBSRegistration> using their valid license agreement details. Please note this site is for registration of Microsoft Business Solutions (Customer Relationship Management) licenses only.



ST. ANNE'S COLLEGE OF ENGINEERING AND TECHNOLOGY
Anguchettypalayam
Panruti Taluk, Cuddalore District

Purchase Order No: SACET /CSE /01/09-10

Date: 27-03-2010

To

J K Systems
Tirunelveli

Sir,

Kindly refer your quotation through email for the following from dated 05-02-2010 and 25-03-2010 and please register this order to the condition overleaf.

Item No	Description	Qty.	Rate / Unit Rs.	Total cost Rs.	Remarks
1.	IBM GEN 2 SERVER X3400 M2 7837 - I2S NEHELAM PROCESSOR Intel Xeon 5504 (Quad Core - NEHELAM) / 2.0 Ghz / 4 MB L3 CACHE / 800 Mhz / 2 GB Memory / 250 GB SATA @ 3.5 " HDD / CD -RW-DVD-ROM / 3 Years On-Site +24*7	2	85,000/-	1,70,000	Delivery at the earliest
2.	IBM Monitor 18.5 "	2	6,500	13,000	
3.	WINDOWS 2008 SERVER WITH 5 USER CAL SOFTWARE	1	27,000	27,000	
	TOTAL			2,10,000	

Thanking You.

Yours sincerely,

H. Helen

Sr. Helen Chandra

Principal
SACET

St. Anne's College of Engineering & Technology,
ANGUCHETTYPALAYAM,
Siruvathur-Post, Panruti-Tk,
Cuddalore-Dist, 607 114

Condition:

Warranty: 3 years from the date of Installation

Payment: Against delivery

Thanking You for
Your valuable order
we accept thanks
by
C.S. Thangarajam.
27/03/10

ST. ANNE'S COLLEGE OF ENGINEERING AND TECHNOLOGY

STOCK LEDGER OF NON-CONSUMABLE STORES

 Name of Article Softwares

Date	Name of Supplier / Supply Order No / To Whom issued	Bill No. & Date	Cost of the Item	Qty. Received	Indent No.	Issued	Balance	Rem
23.04.2009	<u>Windows 2008 Server</u>	99	27,000	30 users				
20.5.2009	C/C++ , windows vista Unid.	2011	255 000/-	85				
11.11.2010	<u>Visual Studio</u>	026	109 800/-	30				
20.11.2010	<u>Oracle 11G</u>	304	2307 000/-	end user				
27.07.2011	<u>Network Simulation</u> <u>Software</u>	1862	2800	1				
13.09.12	<u>TBM Rational Rose</u>	038	307 000/-	1				
16.3.16	<u>Windows 10</u>	0061	1,261 092	30				



ST. ANNE'S COLLEGE OF ENGINEERING AND TECHNOLOGY

(A Unit of the Sisters of St. Anne, Trichirapalli.)

Anguchettypalayam, Siruvathur Post, Panruti Taluk - 607 110. Cuddalore District.

Phone : 04142 - 242661, 243661

Email id : stannescet@gmail.com

Lr. From AICTE File No. 07/08/TN/E&T/2009/20

PRINCIPAL

Purchase orders No: ST.ANNE'S CET /CSE/03/15-16

Date: 11-03-2016

To

Lapsys InfoTech Pvt Ltd,
New No: 12, Old No: 36/2,
V- Block, 11th Street,
Annanagar,
Chennai - 600 040.

Sir,

Sub: Purchasing of FQC-09512 WinPro 10 SNGL Upgrd - reg.

Ref: LIPL -7624-16- dated 04-03-2016.

I would like to place the order for the following Operating System (FQC-09512 WinPro 10 SNGL Upgrd OLP NL Acdmc). Kindly supply the same at the earliest as possible.

S.No.	Description	Qty	Unit Price (INR)	Total Price (INR)
01	FQC-09512 WinPro 10 SNGL Upgrd OLP NL Acdmc.	30	3,496.00	1,04,880.00
			ST@14.5%	15,208.00
			VAT@5.0%	6,004.00
			Grand Total (INR)	1,26,092.00

Thanking You.

Yours sincerely,

R. Arokiadass

11.3.16

Dr. R. AROKIADASS, M.E., Ph.D.,

Principal,

St. Anne's College of Engineering & Technology,

ANGUCHETTYPALAYAM,

Siruvathur-(Post), Panruti-(T.k),

Cuddalore-(Dist) Pin: 607 110

Microsoft Open License Purchase Order A279012 Confirmation

- Authorization Number: 69859225ZZE1803
- License Number: 49878838
- Distributor Purchase Order Number: A279012
- License Date: 2016-03-14
- Agreement Information: Z Academic
- Reorder/Software Assurance End Date: 2018-03-31
- Indirect Reseller: LAPSYS INFOTECH PRIVATE LIMITED

Licensee

- ST Anne's College Of Engineering And Technology
- Anguchettyalayam, Siruvathur post, Panruti Taluk, Cuddalore District Panruti TN 607110 India

Line Items

Product Description	Microsoft Part Number	Version	Quantity
Microsoft Windows Professional 10 Sngl Upgrade Academic OLP 1License NoLevel	FQC-09512	10	30

General Information

This order confirmation is not proof of ownership of any software licenses. You are responsible for paying your reseller for ordered licenses. Software use rights for acquired licenses become permanent once you have made full payment. The official record for this transaction and the Microsoft Open License Agreement (the "License Agreement") that governs your use of the software products displayed above are posted at <https://www.microsoft.com/licensing/servicecenter/> (the "VLSC" Site).

Accessing VLSC

Volume License Service Center (VLSC) provides customers a single, consistent, self-serve experience to securely and easily manage all aspects of software licenses. As an increased security measure, the VLSC Administrator role is automatically assigned to the customer contact whose email address is provided on the Open License order. A partner or other individual from your organization can manage your organization's license(s) once approval is provided by the VLSC Administrator.

Upon logging into VLSC, terms and conditions of the License Agreement will be presented to you after selecting the contract language. You must accept the terms and conditions of the License Agreement before you can use the software products. If you do not agree to the terms and conditions of the License Agreement, do not copy, install, use, access or run the software products and instead, promptly submit your return in writing to your point of purchase. By exercising the rights granted in the License Agreement, you agree to be bound by its terms and conditions.

You can receive all your Microsoft software and future software updates through downloads from the VLSC. If you currently purchase software on discs we invite you to join "Digital by Choice" Microsoft's campaign to eliminate unnecessary shipments of software on physical media (CD/DVD discs). By choosing to download your software from VLSC you can get software updates faster than with kit shipments, save time and effort managing media, and reduce waste and support a more sustainable future. Learn more by visiting <http://www.digitalbychoice.com> OR click the link on the Software Downloads section of the Volume Licensing Service Center: <https://www.microsoft.com/licensing/servicecenter/>.

Volume License Product Key

To install certain licensed products you will need to use a specific Volume License Product Key (VLK). This VLK is issued to your company for your exclusive use for each specific license purchase. You agree to use your best efforts to keep a secure record of this product key including not disclosing this product key to any unauthorized third party. You may see VLKs for older product versions; this is to support downgrade rights under the license agreement where customers can acquire the latest version of a product and use an older version. For more information about Volume License Product Keys, including additional information on key types, best practices, and deployment options, go to the "Volume License Product Key" section of <http://www.microsoft.com/licensing>.

For MSDN Customers Only

MSDN Subscription purchased through Volume License provides access to MSDN Subscription Web Site <http://msdn.microsoft.com/subscriptions> as well as access to Product Keys. MSDN Customers can use Product Keys obtained from either VLSC or MSDN Subscription Web Site for development and test purpose. Please go to the "Subscription" section of VLSC at <https://www.microsoft.com/licensing/servicecenter/Subscriptions.aspx> to manage your MSDN Subscription.

Confidentiality Obligations for Partners

ALL CUSTOMER INFORMATION, INCLUDING THE ATTACHED OPEN LICENSE AUTHORIZATION NUMBER AND OPEN LICENSE AGREEMENT NUMBER, IS STRICTLY CONFIDENTIAL. PARTNERS MAY NOT TRANSFER ANY OF THIS INFORMATION TO ANY THIRD PARTY WITHOUT THE CUSTOMER'S PRIOR CONSENT. IN ADDITION, PARTNERS MAY NOT USE THE OPEN LICENSE AUTHORIZATION NUMBER AND OPEN LICENSE AGREEMENT NUMBER TO VIEW THE CUSTOMER'S CONFIDENTIAL OPEN LICENSE DETAILS ON THE VLSC WEBSITE WITHOUT THE CUSTOMER'S PRIOR WRITTEN CONSENT.

Microsoft

Microsoft Partner
Authorized
Reseller



To,
The Principal,
M/s. ST Anne's College Of Engineering and Technology,
SH 9, Angachettipalayam, Siruvathur post, Panruti - 607110.

Date: 04-03-2016,
Quote No: LIPL -7624-16.

Dear Sir,

In continuation to the discussions with requirement for your Software products; we are hereby presenting our best offer for the following along with terms & conditions for your kind perusal.

We sincerely hope that this is in accordance with your expectation and for any further clarifications in this regard kindly feel free to get in touch with us.

Sn	Description	Qty	Unit Price (INR)	Total Price (INR)	ST@14.5%	VAT@5.0 %	Grand Total (INR)
01	FQC-09512 WinPro 10 SNGL Upgrd OLP NL Acdmc	30	3,496.00	1,04,880.00	15,208.00	6,004.00	1,26,092.00
TOTAL QUOTE VALUE							1,26,092.00

Terms & Conditions:

1. Prices: The Grand Total is inclusive of Base Price+ST@14.5%+VAT@5%.
2. Delivery: 5 -6 Working days.
3. Payment: 100% immediate payment of after completion of delivery.
4. **RGTS**: - Bank Details as Mention below Annexure.
5. Validity: 1 Week.
6. Any Changes in Taxes by the Govt. of India while billing will be subsequently added or subtracted from the value.
7. Installation & Technical Support will be charged as per customer requirement.
8. Media Downloadable.

Orders once placed cannot be cancelled. The cancellation penalty is 50% of order value if cancelled within 2 Working days from the date of your PO, 100% thereafter. The FQC-09478 - WinPro 10 SNGL OLP NL Legalization Get Genuine can't be cancelled.

The prices are valid on USD (\$) Indian INR parity which is subject to variation, the same will reflect in the final price.

Failure to adhere to accepted payment terms can result in automatic cancellation attracting appropriate charges as described above.

The software/license warranties as per manufacturer's terms and conditions.

All disputes relating to this transaction shall be subject to and referred to a court of competent jurisdiction situated within the limits of Chennai.

Thanking you and looking to a long-standing association with your esteemed organization

Lapsys Infotech Pvt Ltd

New No:12, Old No:36/2, V- Block, 11th Street, Annanagar, Chennai - 600 040. TEL: 044 - 4212 5881/2/3,
FAX : 044 - 4212 5885; MAIL: info@lapsysit.com, WEB : www.lapsysit.com
TIN NO: 33911503770 | CST NO: 1066145 | PAN NO: AACCL2574P | SERVICE TAX CODE: AACCL2574PSD001



ST. ANNE'S COLLEGE OF ENGINEERING AND TECHNOLOGY

(Approved by AICTE, New Delhi. Affiliated to Anna University, Chennai)

ANGUCHETTYPALAYAM, PANRUTI – 607 106.

4.Windows 10:

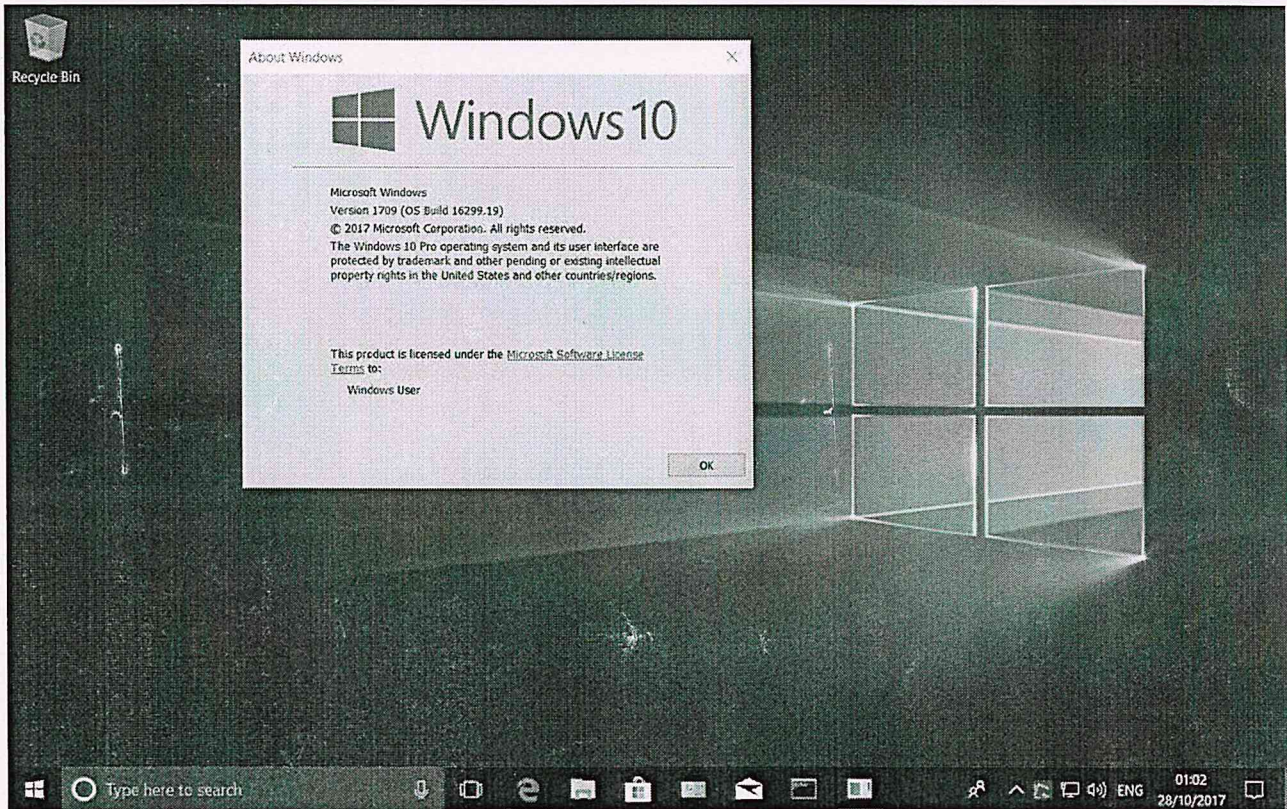



ST. ANNE'S COLLEGE OF ENGINEERING AND TECHNOLOGY

(Approved by AICTE, New Delhi. Affiliated to Anna University, Chennai)

ANGUCHETTYPALAYAM, PANRUTI – 607 106.

APPLICATION SOFTWARES



ST. ANNE'S COLLEGE OF ENGINEERING AND TECHNOLOGY

(Approved by AICTE, New Delhi. Affiliated to Anna University, Chennai)

ANGUCHETTYPALAYAM, PANRUTI – 607 106.

1. Open Nebula:

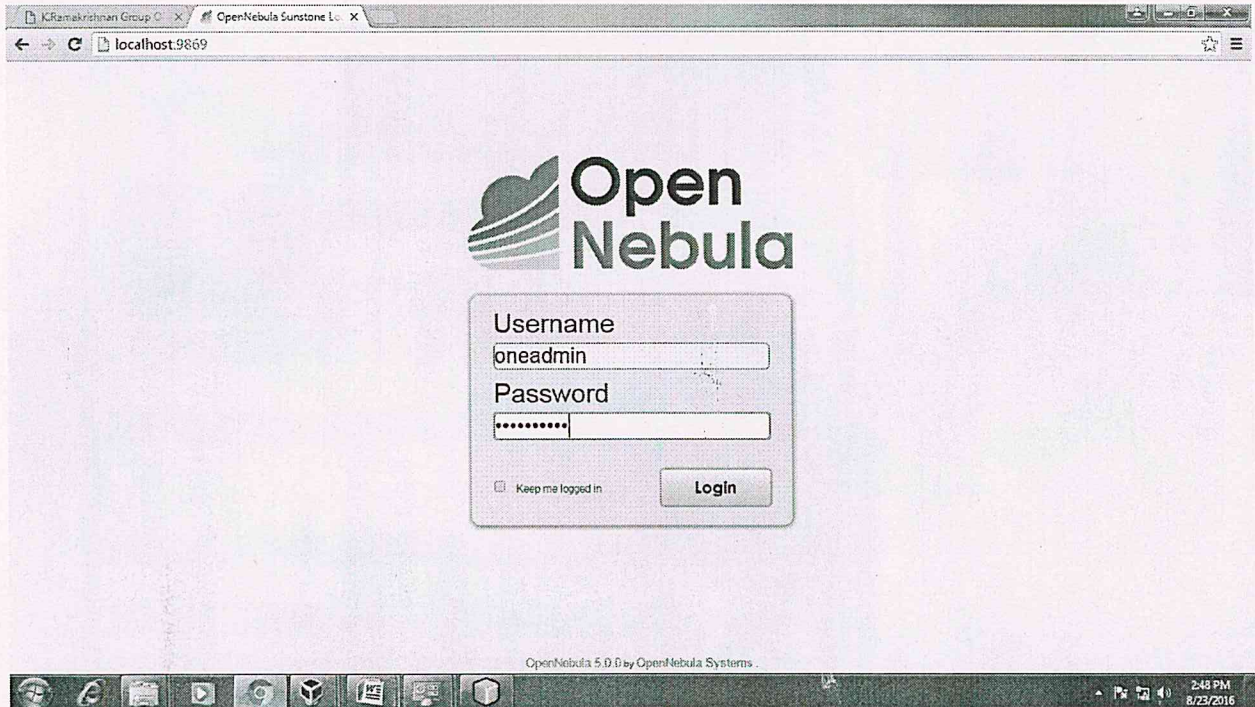



ST. ANNE'S COLLEGE OF ENGINEERING AND TECHNOLOGY

(Approved by AICTE, New Delhi. Affiliated to Anna University, Chennai)

ANGUCHETTPALAYAM, PANRUTI – 607 106.

2.Virtual Box:

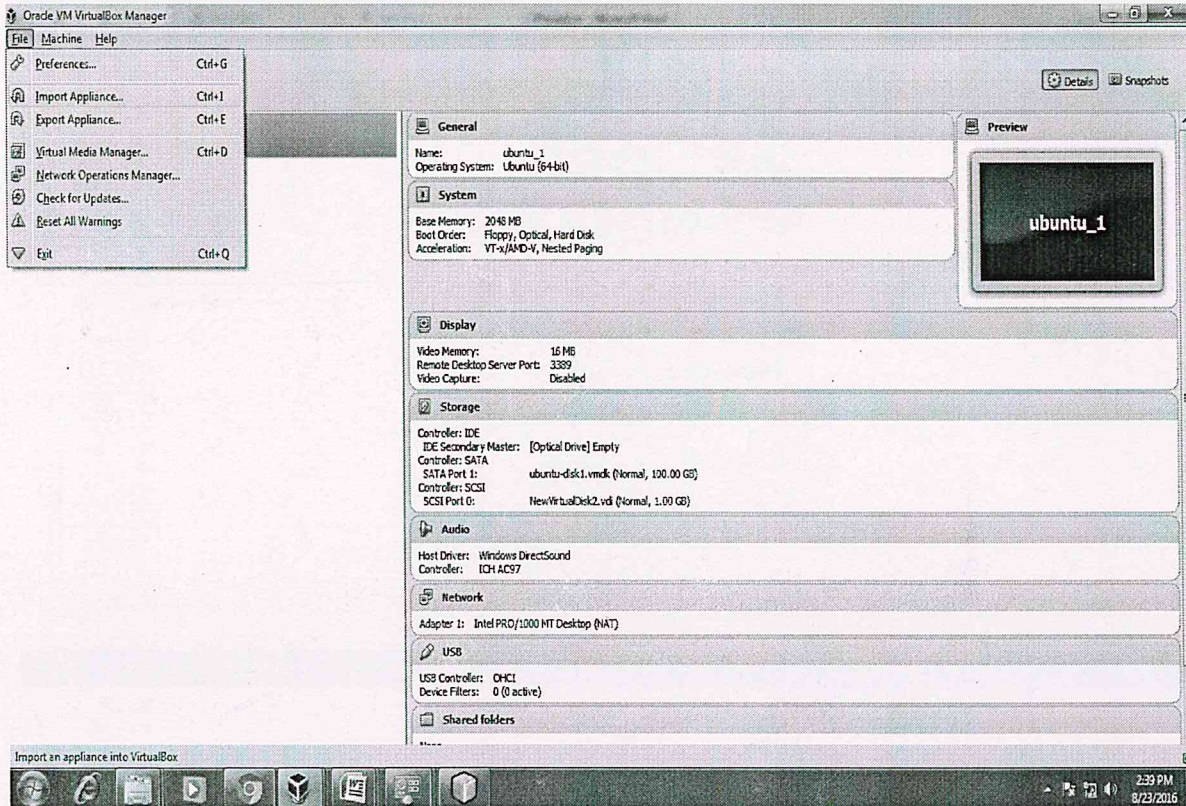



ST. ANNE'S COLLEGE OF ENGINEERING AND TECHNOLOGY

(Approved by AICTE, New Delhi. Affiliated to Anna University, Chennai)

ANGUCHETTYPALAYAM, PANRUTI – 607 106.

3.Hadoop:

The screenshot shows the Hadoop JobTracker web interface in a Mozilla Firefox browser window. The page title is "RUNNING Applications" and the user is logged in as "hdfs". The interface includes a navigation menu on the left with options like "cluster", "jobs", "applications", "NEW", "NEW SAVING", "SUBMITTED", "ACCEPTED", "RUNNING", "FINISHING", "FINISHED", "FAILED", and "KILLED". The main content area displays "Cluster Metrics" and a table of running applications.

Apps Submitted	Apps Pending	Apps Running	Apps Completed	Containers Running	Memory Used	Memory Total	Memory Reserved	Active Nodes	Decommissioned Nodes	Lost Nodes	Unhealthy Nodes	Rebooted Nodes
4	0	1	3	17	1775 GB	56.76 GB	0B	4	0	0	0	0

ID	User	Name	Application Type	Queue	StartTime	Finish Time	State	FinalStatus	Progress	Tracking UI
application_1301056870533_0004	doug	QuasiMonteCarlo	MAPREDUCE	default	Tue, 15 Oct 2013 17:24:16 GMT	N/A	RUNNING	UNDEFINED	<input type="text"/>	ApplicationMaster

Showing 1 to 1 of 1 entries

[About Apache Hadoop](#)



ST. ANNE'S COLLEGE OF ENGINEERING AND TECHNOLOGY

(Approved by AICTE, New Delhi. Affiliated to Anna University, Chennai)

ANGUCHETTPALAYAM, PANRUTI – 607 106.

4. Globus Tool Kit:

```
dinesh@dinesh-VirtualBox: /opt/axis2/axis2-1.7.3/bin
dinesh@dinesh-VirtualBox: /opt/axis2/axis2-1.7.3/bin$ ./axis2server.shserver.sh
Using AXIS2_HOME: /opt/axis2/axis2-1.7.3
Using JAVA_HOME: /usr/lib/jvm/java-8-oracle
[INFO] [SimpleAxisServer] Starting
[INFO] [SimpleAxisServer] Using the Axis2 Repository/opt/axis2/axis2-1.7.3/repository
[SimpleAxisServer] Using the Axis2 Repository/opt/axis2/axis2-1.7.3/repository
[SimpleAxisServer] Using the Axis2 Configuration File/opt/axis2/axis2-1.7.3/conf/axis2.xml
[INFO] Clustering has been disabled
[INFO] Deploying module: addressing-1.7.3 - file:/opt/axis2/axis2-1.7.3/repository/modules/addressing-1.7.3.mar
[INFO] Deploying module: soapmonitor-1.7.3 - file:/opt/axis2/axis2-1.7.3/repository/modules/soapmonitor-1.7.3.mar
[INFO] Deploying module: mtompolicy-1.7.3 - file:/opt/axis2/axis2-1.7.3/repository/modules/mtompolicy-1.7.3.mar
[INFO] Deploying module: metadataExchange-1.7.3 - file:/opt/axis2/axis2-1.7.3/repository/modules/mex-1.7.3.mar
[INFO] Deploying module: script-1.7.3 - file:/opt/axis2/axis2-1.7.3/repository/modules/scripting-1.7.3.mar
[INFO] Deploying module: ping-1.7.3 - file:/opt/axis2/axis2-1.7.3/repository/modules/ping-1.7.3.mar
[INFO] Deploying Web service: version.aar - file:/opt/axis2/axis2-1.7.3/repository/services/version.aar
[INFO] Deploying artifact : /opt/axis2/axis2-1.7.3/repository/servicejars/jaxws-calculator-1.7.3.jar
[INFO] Deploying JAXWS annotated class org.apache.axis2.jaxws.calculator.CalculatorService as a service - CalculatorService
[INFO] Listening on port 8080
[INFO] [SimpleAxisServer] Started
[SimpleAxisServer] Started
```



ST. ANNE'S COLLEGE OF ENGINEERING AND TECHNOLOGY

(Approved by AICTE, New Delhi. Affiliated to Anna University, Chennai)
ANGUCHETTYPALAYAM, PANRUTI – 607 106.

5. Android Studio:

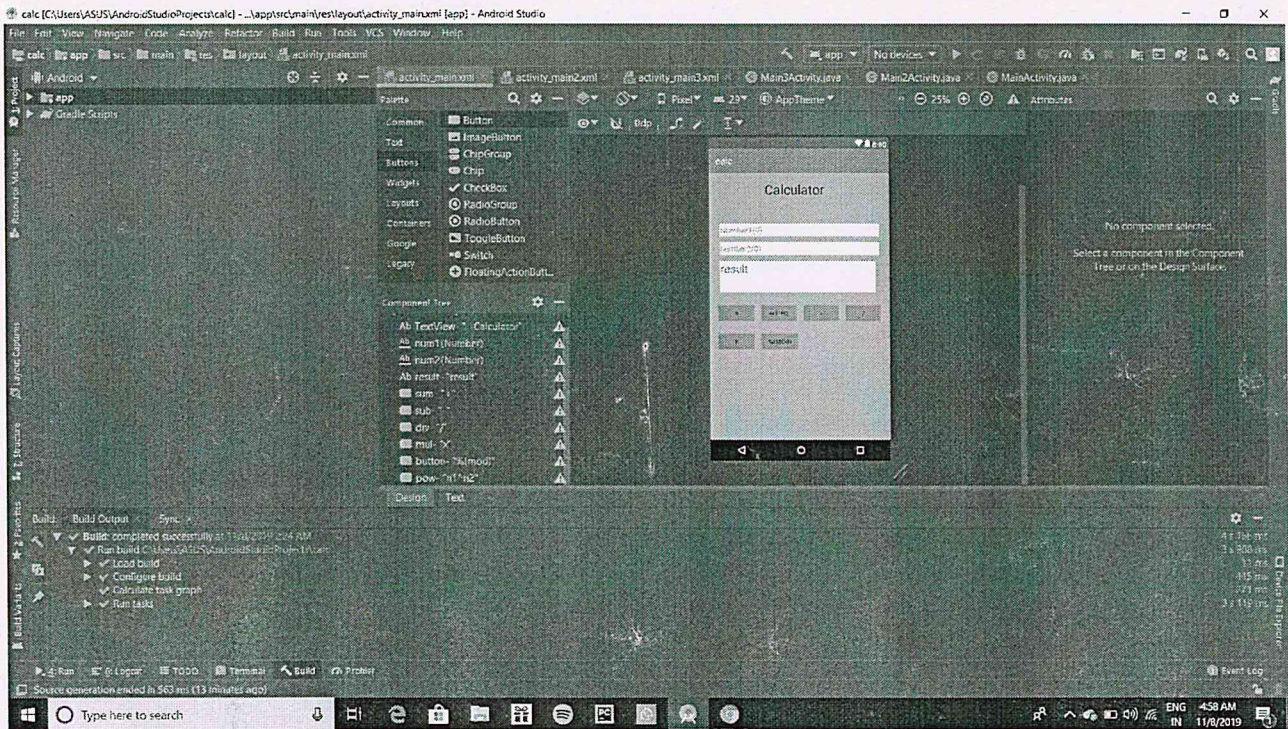



ST. ANNE'S COLLEGE OF ENGINEERING AND TECHNOLOGY

(Approved by AICTE, New Delhi. Affiliated to Anna University, Chennai)

ANGUCHETTYPALAYAM, PANRUTI – 607 106.

6.Netbeans:

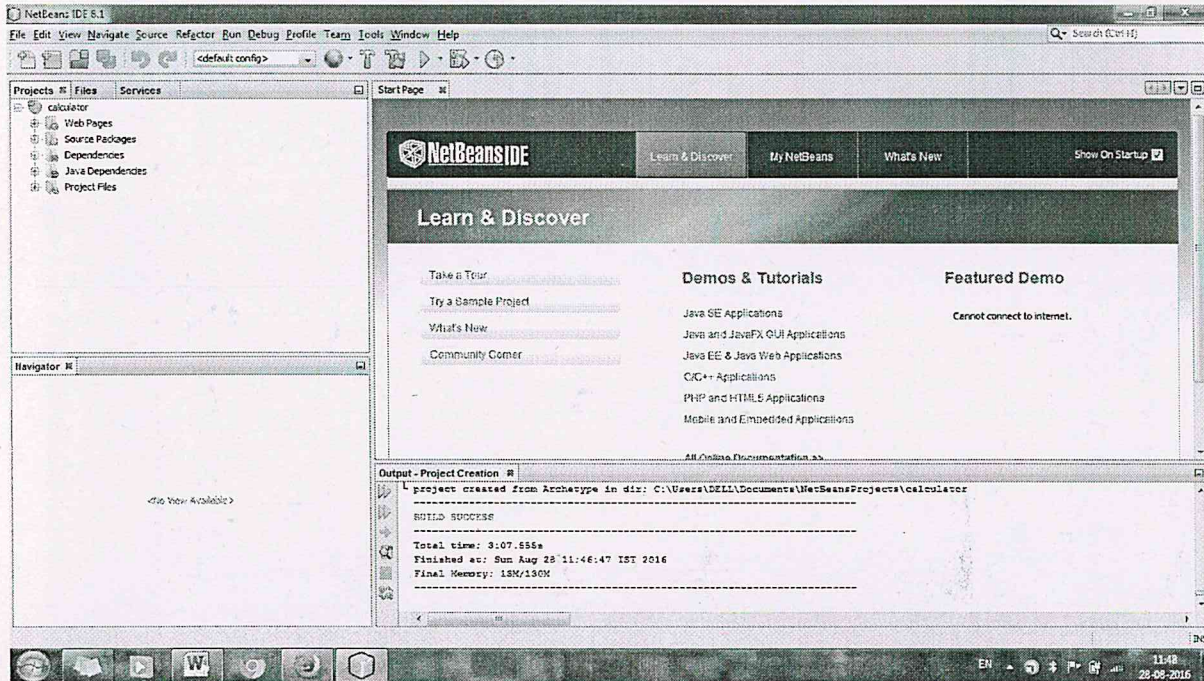



ST. ANNE'S COLLEGE OF ENGINEERING AND TECHNOLOGY

(Approved by AICTE, New Delhi. Affiliated to Anna University, Chennai)

ANGUCHETTYPALAYAM, PANRUTI - 607 106.

7. N-Stalker Tool:

Report Options

Executive Report
https://www. :443/

Report Options | Vulnerabilities | PDF Options

Header Title
N-Stalker Web Application Security Assessment

Special Notes

URL Information
http://www.nstalker.com/

Footnotes
Confidential Information. Unauthorized duplication or exposure of its content is strictly forbidden.

Page Information
Generated by N-Stalker Web Application Security Scanner - Page

Vendor Name
N-Stalker Web Application Security Scanner

Cover Image

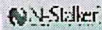
Header Image

Generate **Cancel**



ST. ANNE'S COLLEGE OF ENGINEERING AND TECHNOLOGY

(Approved by AICTE, New Delhi. Affiliated to Anna University, Chennai)

ANGUCHETTYPALAYAM, PANRUTI - 607 106.

8. Root Kit Hunter:

```
yuyudhn@LINUXSEC:~$ sudo rkhunter --check
[ Rootkit Hunter version 1.4.6 ]

Checking system commands...

Performing 'strings' command checks
Checking 'strings' command [ OK ]

Performing 'shared libraries' checks
Checking for preloading variables [ None found ]
Checking for preloaded libraries [ None found ]
Checking LD_LIBRARY_PATH variable [ Not found ]

Performing file properties checks
Checking for prerequisites [ Warning ]
/usr/sbin/adduser [ OK ]
/usr/sbin/chroot [ OK ]
/usr/sbin/cron [ OK ]
/usr/sbin/groupadd [ OK ]
/usr/sbin/groupdel [ OK ]
/usr/sbin/groupmod [ OK ]
/usr/sbin/grpck [ OK ]
/usr/sbin/nologin [ OK ]
/usr/sbin/pwck [ OK ]
/usr/sbin/rsyslogd [ OK ]
/usr/sbin/useradd [ OK ]
/usr/sbin/userdel [ OK ]
/usr/sbin/usermod [ OK ]
/usr/sbin/vipw [ OK ]
/usr/sbin/unhide [ OK ]
```



ST. ANNE'S COLLEGE OF ENGINEERING AND TECHNOLOGY

(A Unit of the Sisters of St. Anne, Trichirapalli.)

Anguchettypalayam, Siruvathur Post, Panruti Taluk - 607 110. Cuddalore District.

Phone : 04142 - 242661, 243661

Email id : stannescet@gmail.com

Lr. From AICTE File No. 07/08/TN/E&T/2009/20

PRINCIPAL Supply order No: CSE/SW/01/2012-13

Date: 26-06-2012

To:

The Manager,
Micro genesis techsoft private Ltd.
Bagalore.

Sir,

Kindly refer your quotation for IBM Rational Software and please register this order and supply it immediately with the terms and Conditions as below.

S. No	Particulars	Unit Price (Rs.)	Qty	Amount (Rs.)
1	IBM Rational Software Architect & Rational Enterprise suite with tax 5% 30 User License 4 Days training at our campus for 16 members 2 media	3,07,000.00	1	3,07,000.00
			Total	3,07,000.00

Terms & Conditions	
Taxes	Includes of all Taxes
Delivery	2 weeks from the date of PO
Payment	100% Advance
Validity	1 Week

Herewith I have enclosed Demand draft bearing No: 549426, Dated 25. 06. 2012 for RS.

3,07,000/- (Three laks and seven thousand) as drawn in favour of MICRO GENESIS

TECHSOFT PRIVATE LTD. Payable at BANGALORE.

Received the order
by

Elumy J...

Yours Sincerely

J. G. ...
26/6/12
Principal

St. Anne's College of Engineering & Technology
ANGUCHETTYPALAYAM,
Siruvathur Post, Panruti T.k.,
Cuddalore-Dist, 607 110.

MICROGENESIS TECHSOFT PVT LTD
No 3001, 5th Cross, 12-A Main, HAL 2nd Stage
Indira Nagar, Bangalore - 560 008
Tel: 080 - 4072 2100; Fax: 080 - 4152 2108



TAX INVOICE

To
St. Anne's College of Engineering & Technology
Anguchettyalayam, Siruvathur Post
Panruti Taluk - 607 110, Cuddalore District

Inv No BLR/038/12-13

Date 13-Sep-12

PO No. CSE/SW/01/2012-13

Dated: 26.06.2012

SI No	Description	Cost	Qty	Total
1	IBM Rational Software Architect & Rational Enterprise Suite	290,995	1	290,995
Add: CST @ 5.5%				16,005
Grand Total				307,000

VAT TIN NO.: 29160377351
PAN NO.: AAECM1175F
SERVICE TAX REGD NO.: AAECM1175F ST001

Rupees in words

Three lakh seven thousand only.

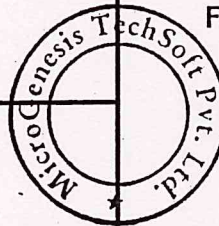

For MicroGenesis TechSoft Pvt Ltd

M. Sathish Shetty

Authorised Signatory

Regd Office: No 3001, 5th Cross, 12th 'A' Main, Indira Nagar, HAL 2nd Stage, Bangalore - 560 008.

Note: Payment of Rs. 3,07,000/- received vide DD No. 549426 dtd 25.06.2012 of Tamilnad Mercantile Bank Ltd.



Quote No: SOF/12-13/MAR/280
Quote Dt: 28/03/2012

To:
St. Anne's College of Engineering & Technology
Panruti

file

Academic Offer for IBM Rational Seed Training Program

Dear Sir,

Thank you for given the opportunity to quote the following and we are looking forward to receive your valuable orders. Assuring of our best attention and co-operation at all times.

S.No.	Particulars	Unit Price (Rs.)	Qty	Amount (Rs.)
1	IBM Rational Software Architect & Rational Enterprise suite 30 User License 4 Days training at our campus for 16 members 2 media	315,000.00	1	315,000.00
Taxes : 5%				15,750.00
** Rupees Three lakhs Thirty thousand and Seven Hundred and Fifty only **			Total	330,750.00

Terms & Conditions

Taxes	Includes of all Taxes
Delivery	2 weeks from the date of PO
Payment	100% Advance
Validity	1 Week

For easy reference, please indicate our quotation number in your purchase order

For any enquiry, please contact:

T.Dhanasekaran
Phone no: +9198429 16163
Email ID: villupuram@ateamcs.in

For A - TEAM COMPUTERS

AUTHORISED SIGNATORY

122, S.K.S. Buildings, Perundurai Road, Erode-638011. 0424-650196/6504606 Fax: 4270969

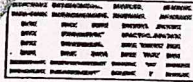

Rational software

ANNEXURE-A

ENROLLMENT FORM

IBM Rational Software Product Licensing Program

This form provides information necessary for application to IBM Rational's Product Licensing Program. IBM Rational's Program offers certain select product licenses FREE of charge on meeting specified conditions, to approve and accredited academic institutions in India for educational purposes.

Application Date: 23-07-2012
Product Applied for: IBM Rational SEED Training Programme.
Through IBM Rational Partner: MicroGenesis Techsoft.Pvt.Ltd,Bangalore-560008.

Form with fields: Name of Institution, Contact Name, Description products, Media, Name of administrative authority.

IBM Rational Program Administrator
Signature with seal
Date

Authorized Signatory
Signature with seal of Institute
Date 23-7-12

Secretary,
St. Anne's College of Engineering & Technol.
ANGUCHETTYPALAYA..
Siruvathur-Post, Panruti-Tk,
Cuddalore-Dist, 607 110.

Name: KUNAL DUREJA
Title: COUNTY MANAGER
- CAREER EDUCATION.

Name: Sr. Victoria
Title: Secretary

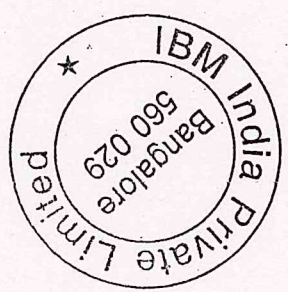



ST. ANNE'S COLLEGE OF ENGINEERING AND TECHNOLOGY

(Approved by AICTE, New Delhi. Affiliated to Anna University, Chennai)
ANGUCHETTYPALAYAM, PANRUTI – 607 106.

9.Rational Rose:

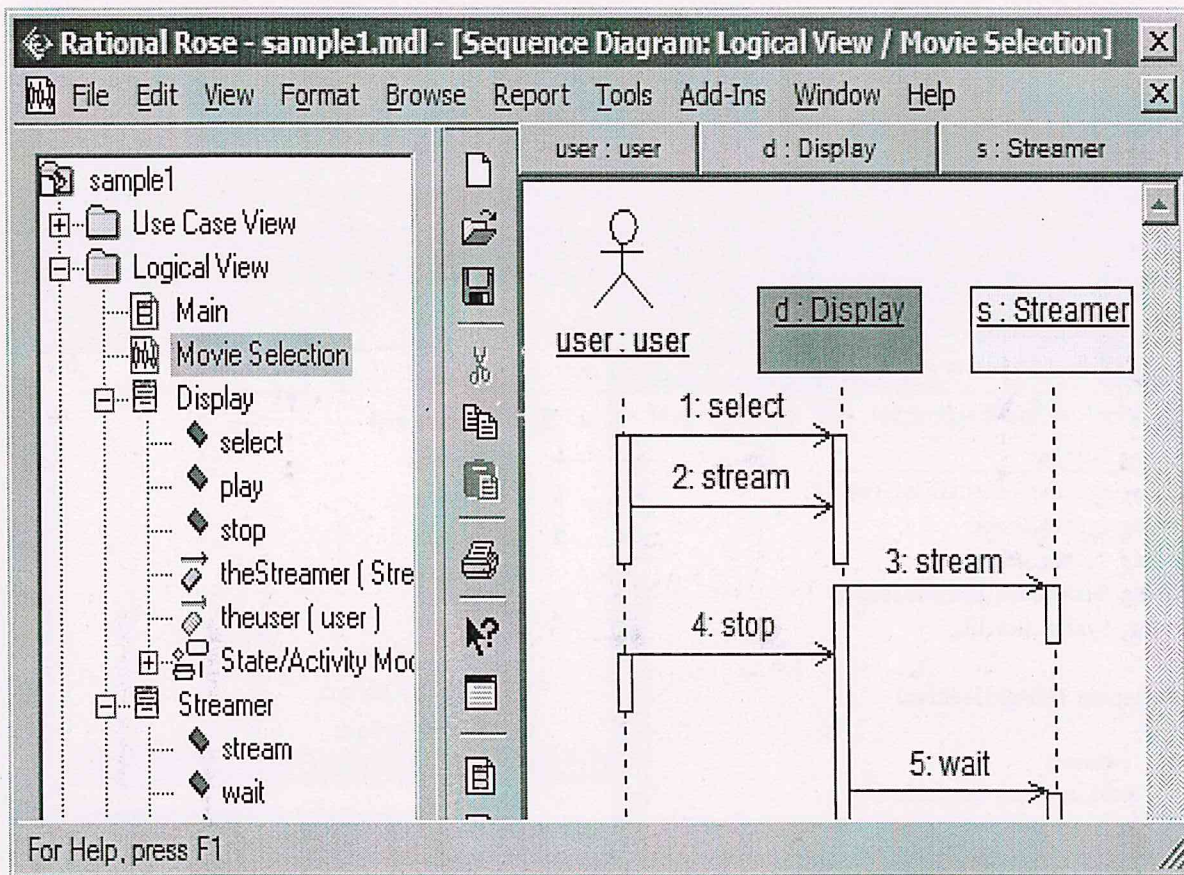



ST. ANNE'S COLLEGE OF ENGINEERING AND TECHNOLOGY

(Approved by AICTE, New Delhi. Affiliated to Anna University, Chennai)

ANGUCHETTYPALAYAM, PANRUTI – 607 106.

10. Visual Studio:

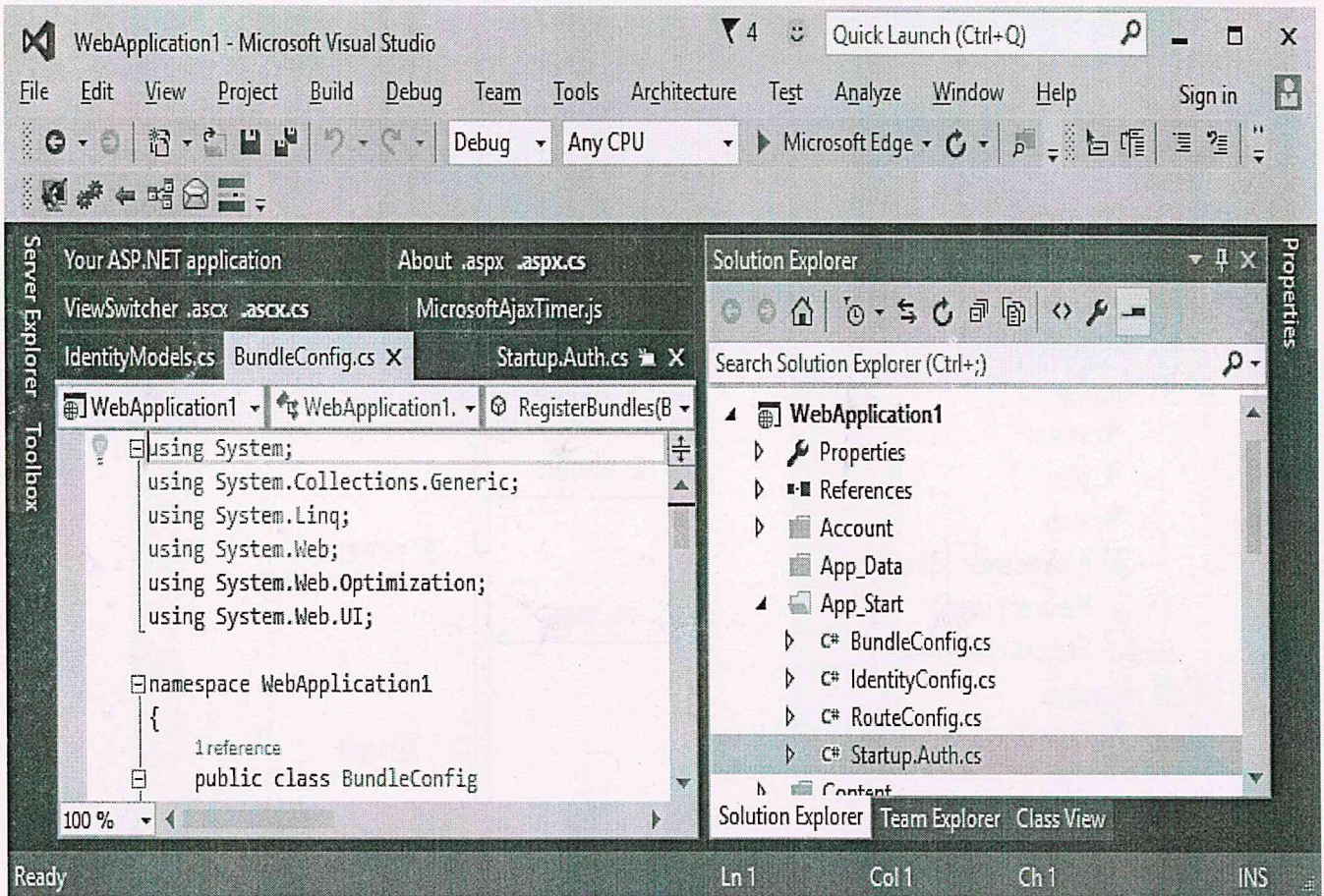

Is it genuine? Verify the Holographic Security thread is interwoven and passes through the holes in the paper. The inside edge of each hole is uniquely shaped from random paper fibers. When viewed from the back, the embedded thread is fully visible only within each hole. For further details, go to www.howtotell.com.

Microsoft Open License Agreement

THE PRINCIPAL, ST. ANNES COLLEGE OF ENGINEERING
AND TECHNOLOGY
ANGUCHETTYPALAYAM
SIRUVATHUR POST
PANRUTI-TK TN 607110
INDIA

0005002172

Licensee Authorization Number

67718927ZZE1211

License Agreement Number

47722506

Licensee Reference (if any)

<i>Issue Date of the Initial License Agreement</i>	<i>Issue Date of this License Agreement</i>	<i>Last Date for Repeat Orders/ End of Maintenance Coverage</i>
26 November 2010	26 November 2010	30 November 2012
<i>Product Pool</i>	<i>Volume Pricing Level</i>	<i>License Program</i>
Not Applicable	No Level	Educational

<i>Product Description</i>	<i>Microsoft Product Number</i>	<i>Version</i>	<i>Copies Licensed or Maintained</i>
VSPro 2010 SNGL OLP NL Acdmc	C5E-00710	2010	**30**

*****End of license, total line of items is 1*****

Total quantity for License Agreement Number **47722506 is **30****

Volume License Product Key. To install certain licensed products you will need to use a specific Volume License Product Key (VLK). This VLK is issued to your company for your exclusive use for each specific license purchase. You agree to use your best efforts to keep a secure record of this product key including not disclosing this product key to any unauthorized third party. For more information about Volume License Product Keys and Key Types, go to the "Volume License Product Key" section of <http://www.microsoft.com/licensing>.

Customers who acquire Microsoft Business Solutions software must acquire a Registration Key to enable the software by registering at: <http://www.microsoft.com/BusinessSolutions/MBSRegistration> using their valid license agreement details. Please note this site is for registration of Microsoft Business Solutions (Customer Relationship Management) licenses only.

PROFORMA INVOICE**INDISS**

INDICOM SOFTWARE AND SERVICES

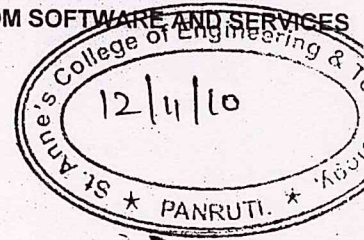

To

The Prinipal
St. Annes College of Engineering and Technology
Anguchettpalayam, Siruvathur Post,
Panruti

In No :026

Date : November 11, 2010

VAT TIN No:33680923594

CST No : 790452/08.01.2003

Area Code: 047

S.No	Product Description	Rate (Rs)	Qty	Amount (Rs)
1	MS Visual Studio professional 2010 License	3,152.00	30	94,560.00
2	Media Kit-Ms Visual Studio Pro 2010	1,300.00	1	1,300.00
	Total			95,860.00
	Add Service Tax 10.3%			9,739.68
	Total			105,599.68
	Add VAT 4%			4,223.99
	ToTal			109,823.67
	Round off			109,822.00

Terms and Conditions:

1. **Price:** Net Total inclusive of all tax.
2. **Payment:** 100% advance in favour of Indicom Software and Services, payable at chennai.

for Indicom Software and Services

Authorised Signatory

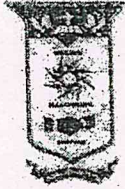

ST. ANNE'S COLLEGE OF ENGINEERING AND TECHNOLOGY

(A Unit of the Sisters of St. Anne, Trichirapalli)

Anguchettypalayam, Siruvathur Post, Panruti Taluk, Cuddalore District.

Phone: 04142-242661, 243661

Email id: stannescet@gmail.com

Lr. From AICTE File No. 07/08/TN/E&T/2009/20

PRINCIPAL

Supply order No: CSE/SW/01/2010-11

Date: 09-11-2010

To:

The Manager,
INDICOM software,
B94, 13th West Street,
Kamaraj Nagar, Thiruvanniyur,
Chennai - 600041.

Sir,

Kindly refer to your quotation dated 01-11-2010 for the following software and please register this order to the condition overleaf.

Item No	Description	Qty.	Rate / Unit Rs.	Total cost Rs.	Remarks
1	MS Visual studio Professional 2010 License.	30 User	3152.00	94560.00	Delivery at the earliest
Service Tax @10.3%				9739.00	
VAT 4%				4171.00	
TOTAL				1,08,470.00	
2	MS Visual Studio Professional 2010 media kit	1	1300.00	1300.00	
VAT @ 4%				52.00	
TOTAL				1,352.00	
GRAND TOTAL (1,08,470 + 1,352)				1,09,822.00	

Terms & Conditions:

TAX : Included.
PAYMENT TERMS : 100% Advance.

Thanking You.

Yours sincerely,

[Signature]
Principal

St. Anne's College of Engineering & Technology,
ANGUCHETTYPALAYAM,
Siruvathur Post, Panruti Taluk,
Cuddalore Dist, 607 112

Received.
The original
Purchase order.

[Signature]
N. Suresh



ST. ANNE'S COLLEGE OF ENGINEERING AND TECHNOLOGY

(Approved by AICTE, New Delhi. Affiliated to Anna University, Chennai)

ANGUCHETTYPALAYAM, PANRUTI – 607 106.

11.Node –Js:

```
1 const express = require('express'),
2   router = express.Router();
3   movie_info = require('../models/movie_info')
4
5   router.get('/test', (req, res) => {
6     res.send('something works'); //res.render('/',/views/index.html'
7   });
8
```

Line 3, Column 5 Tab Size: 4 JavaScript



ST. ANNE'S COLLEGE OF ENGINEERING AND TECHNOLOGY

(Approved by AICTE, New Delhi. Affiliated to Anna University, Chennai)

ANGUCHETTYPALAYAM, PANRUTI – 607 106.

12.Uipath Tool:

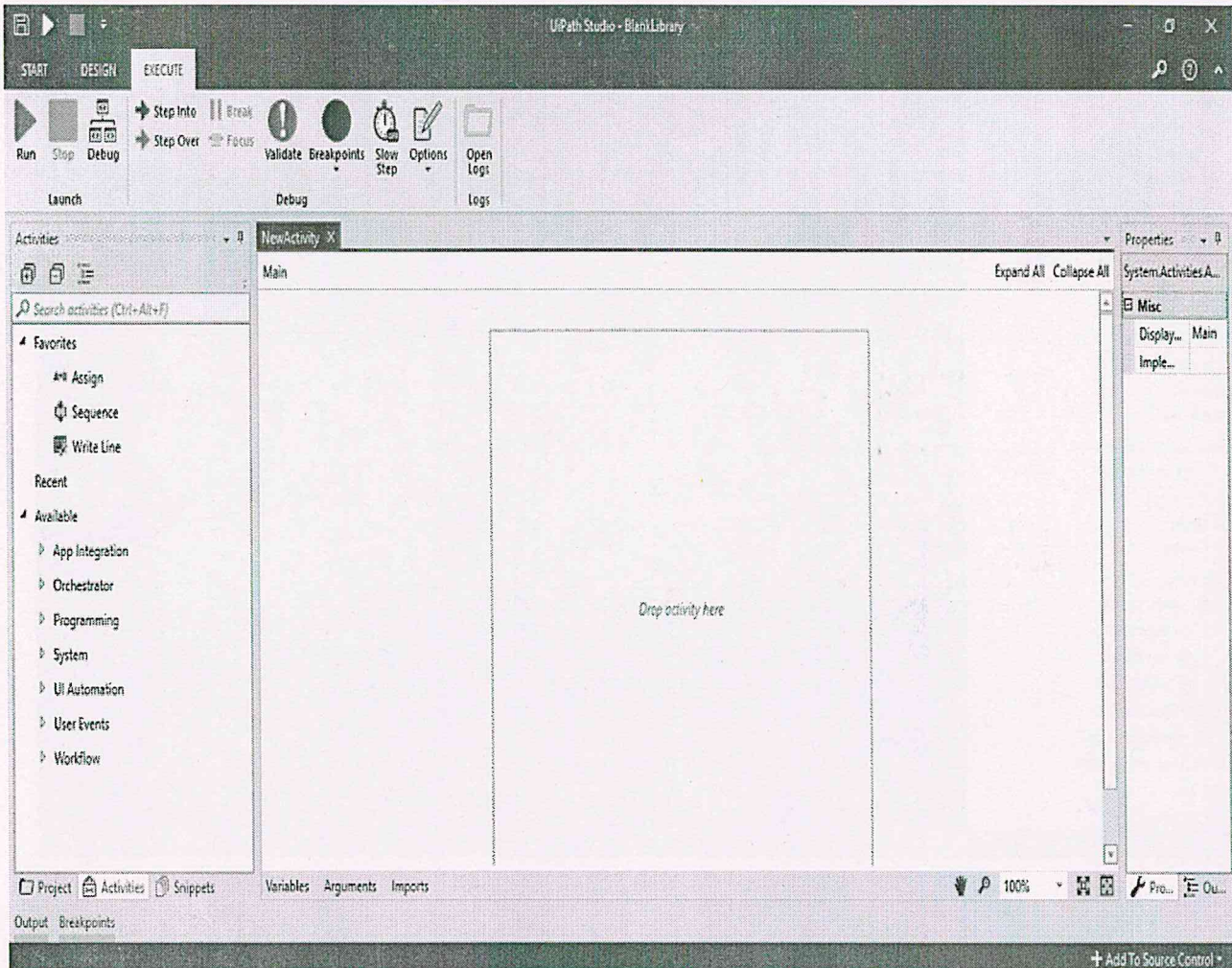



ST. ANNE'S COLLEGE OF ENGINEERING AND TECHNOLOGY

(Approved by AICTE, New Delhi. Affiliated to Anna University, Chennai)
ANGUCHETTYPALAYAM, PANRUTI – 607 106.

13. R Language:

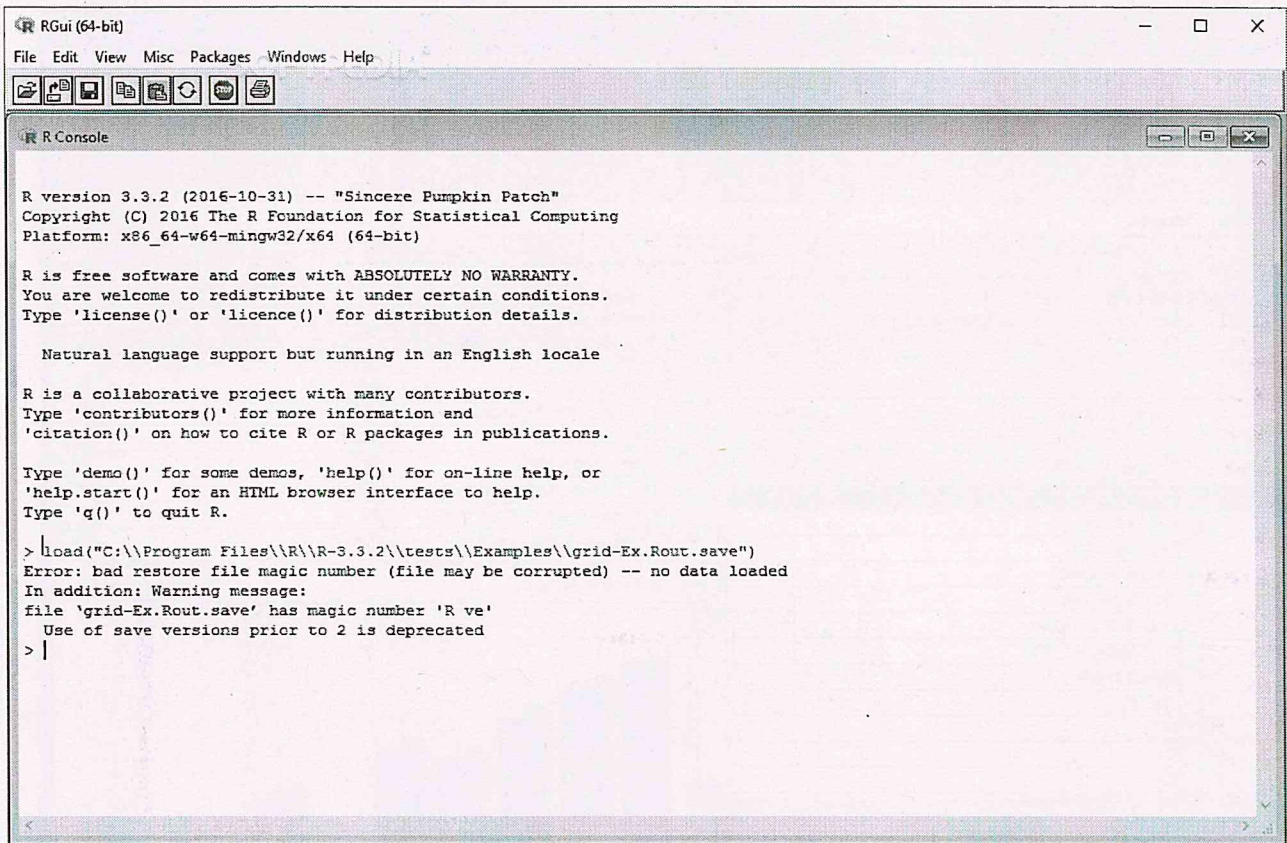

```
RGui (64-bit)
File Edit View Misc Packages Windows Help
R R Console
R version 3.3.2 (2016-10-31) -- "Sincere Pumpkin Patch"
Copyright (C) 2016 The R Foundation for Statistical Computing
Platform: x86_64-w64-mingw32/x64 (64-bit)

R is free software and comes with ABSOLUTELY NO WARRANTY.
You are welcome to redistribute it under certain conditions.
Type 'license()' or 'licence()' for distribution details.

Natural language support but running in an English locale

R is a collaborative project with many contributors.
Type 'contributors()' for more information and
'citation()' on how to cite R or R packages in publications.

Type 'demo()' for some demos, 'help()' for on-line help, or
'help.start()' for an HTML browser interface to help.
Type 'q()' to quit R.

> load("C:\\Program Files\\R\\R-3.3.2\\tests\\Examples\\grid-Ex.Rout.save")
Error: bad restore file magic number (file may be corrupted) -- no data loaded
In addition: Warning message:
file 'grid-Ex.Rout.save' has magic number 'R ve'
Use of save versions prior to 2 is deprecated
> |
```



ST. ANNE'S COLLEGE OF ENGINEERING AND TECHNOLOGY

(Approved by AICTE, New Delhi. Affiliated to Anna University, Chennai)

ANGUCHETTPALAYAM, PANRUTI – 607 106.

14. Weka Tool:

The screenshot shows the Weka Explorer interface. The 'Preprocess' tab is active. The 'Filter' is set to 'None'. The 'Current relation' is 'Full dataset' with 2825 instances and 28 attributes. The 'Attributes' list includes 'WASG_DECODE', 'Row Number', 'Latitude 1 dec', 'Longitude 1 dec', 'Elevation 0 dec', 'O_LATITUDE_GDA', 'O_LONGITUDE_GDA', 'Elevation (M)', 'CACO3', 'OC', 'PH', and 'clay'. The 'Selected attribute' is 'WASG_DECODE', which is a nominal attribute with 10 distinct values and 30 missing values (1%). The 'Label' and 'Count' table is as follows:

Label	Count
Loamy_gravel	612
Grey_deep_sandy_duplex	532
Pale_deep_sand	453
Yellow_deep_sand	326
Grey_shallow_sandy_duplex	358
Red/brown_non-cracking_clay	89
Calcareous_loamy_earth	226

The 'Class: ExKP (Num)' is selected, and a bar chart is displayed showing the distribution of the 'WASG_DECODE' attribute. The bars represent the counts for each label: Loamy_gravel (612), Grey_deep_sandy_duplex (532), Pale_deep_sand (453), Yellow_deep_sand (326), Grey_shallow_sandy_duplex (358), Red/brown_non-cracking_clay (89), and Calcareous_loamy_earth (226). The status bar shows 'OK' and a 'Log' button.



ST. ANNE'S COLLEGE OF ENGINEERING AND TECHNOLOGY

(Approved by AICTE, New Delhi. Affiliated to Anna University, Chennai)
ANGUCHETTYPALAYAM, PANRUTI – 607 106.

15.PHP:

```
1 <?php namespace October\Demo;
2
3 /**
4  * The plugin.php file (called the plugin initialization script) defines the pl
5  */
6
7 use System\Classes\PluginBase;
8
9 class Plugin extends PluginBase
10 {
11
12     public function pluginDetails()
13     {
14         return [
15             'name' => 'October Demo',
16             'description' => 'Provides features used by the provided demonstrat
17             'author' => 'Alexey Bobkov, Samuel Georges',
18             'icon' => 'icon-leaf'
19         ];
20     }
21
22     public function registerComponents()
23     {
24         return [
25             '\October\Demo\Components\Todo' => 'demoTodo'
26         ];
27     }
28 }
```



ST. ANNE'S COLLEGE OF ENGINEERING AND TECHNOLOGY

(Approved by AICTE, New Delhi. Affiliated to Anna University, Chennai)
ANGUCHETTYPALAYAM, PANRUTI - 607 106.

16.VIRT Sim:

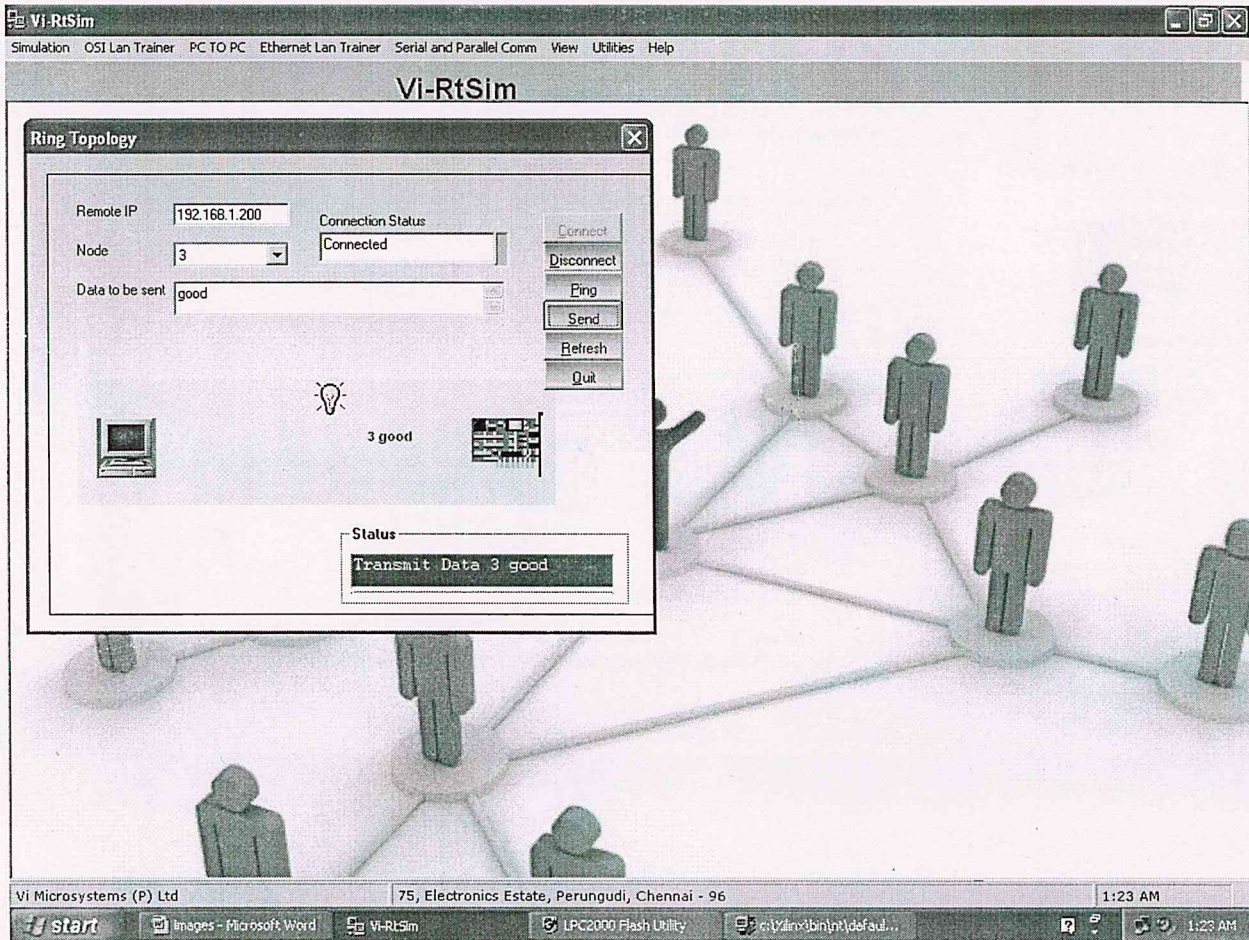



ST. ANNE'S COLLEGE OF ENGINEERING AND TECHNOLOGY

(Approved by AICTE, New Delhi. Affiliated to Anna University, Chennai)

ANGUCHETYPALAYAM, PANRUTI – 607 106.

DATABASE SOFTWARES



ST. ANNE'S COLLEGE OF ENGINEERING AND TECHNOLOGY

(Approved by AICTE, New Delhi. Affiliated to Anna University, Chennai)

ANGUCHETTYPALAYAM, PANRUTI – 607 106.

1.Xamp Server:

The screenshot displays the XAMPP Control Panel v3.2.2 interface. The window title is "XAMPP Control Panel v3.2.2 [Compiled: Nov 12th 2015]". The main area features a table of services and a sidebar with utility buttons.

Service	Module	PID(s)	Port(s)	Actions
<input type="checkbox"/>	Apache			Start Admin Config Logs
<input type="checkbox"/>	MySQL			Start Admin Config Logs
<input type="checkbox"/>	FileZilla			Start Admin Config Logs
<input type="checkbox"/>	Mercury			Start Admin Config Logs
<input type="checkbox"/>	Tomcat			Start Admin Config Logs

Utility buttons on the right: Config, Netstat, Shell, Explorer, Services, Help, Quit.

Log output at the bottom:

```
09:38:36 [main] Initializing Control Panel
09:38:36 [main] Windows Version: Windows 7 Professional SP1 64-bit
09:38:36 [main] XAMPP Version: 5.6.15
09:38:36 [main] Control Panel Version: 3.2.2 [ Compiled: Nov 12th 2015 ]
09:38:36 [main] You are not running with administrator rights! This will work for
09:38:36 [main] most application stuff but whenever you do something with services
09:38:36 [main] there will be a security dialogue or things will break! So think
09:38:36 [main] about running this application with administrator rights!
09:38:36 [main] XAMPP Installation Directory: "c:\xampp\"
09:38:36 [main] Checking for prerequisites
```



LICENSE CERTIFICATE

S.No. IN 126763 / 2010

Generated on: 03 DEC 2010

CSI#: 17722213

This is a certificate of authenticity that the software you have procured is legally licensed by Oracle India Private Limited.

Purchased through:

Licensee:

Orington India Limited
Corporate Office
95, SPL Guindy House, Guindy
Chennai
Tamilnadu
600032

St. Anne's College of Engineering and
Technology
Siruvathur PO, Anguchettyapalayam,
Panruti Taluk
CUDDALORE
TAMILNADU
607110

Products

User/Units

License Type

Oracle Standard Edition One - Oracle 1-Click
Ordering eDelivery - Processor Perpetual

1

FULL USE



ST. ANNE'S COLLEGE OF ENGINEERING AND TECHNOLOGY

(A Unit of the Sisters of St. Anne, Trichirapalli)

Anguchettypalayam, Siruvathur Post, Panruti - Taluk, Cuddalore District.

Phone: 04142-242661, 243661

Email id: stannescet@gmail.com

Lr. From AICTE File No. 07/08/TN/E&T/2009/20

PRINCIPAL

Supply order No: CSE/SW/02/2010-11

Date: 09-11-2010

To:

The Manager,
J.K. SYSTEMS
182E/82A, First Floor,
S. N. High Road,
Tirunelveli- 627001.

Sir,

Kindly refer to your quotation dated 16-09-2010 for the following software and please register this order to the condition overleaf.

Item No	Description	Qty.	Total Cost Rs.	Remarks
01	Oracle 11 G	Unlimited	2,30,000.00	Delivery at the earliest
TOTAL			2,30,000.00	

Terms & Conditions:

TAX : Included.
PAYMENT TERMS : 100% Advance.

Thanking You:

Yours sincerely,

Principal

St. Anne's College of Engineering & Technology,
ANGUCHETTYPALAYAM,
Siruvathur-Post, Panruti-Tk,
Cuddalore-Dist, 605 011

Thanking You for
your valuable order,
WE Accept your order.

For, J.K. SYSTEMS
182 E/2A, 1st floor
S.N High Road,
Tirunelveli - 627001

CASH / CREDIT BILL

TIN : 33275641560



J.K.SYSTEMS

(Dealers for Computer Consumables & Peripherals)
 182E/2A, I Floor, S.N. High Road, Tirunelveli - 627 001.
 Ph : 4000642, Mobile : 98421-66642/94431-56642

No. 304

Date :

M/S. St. Anne's College of Engg. & Tech,
 Angu Chetti Palayam Panruti

Sl. No.	Description	Rate	Qty	Amount	
				Rs.	Ps.
1	Oracle 11g Software Unlimited usage License	2,30,000	1	2,30,000	00
(Rs two lakh and thirty thousand only)					
				2,30,000	00

Goods Once sold cannot be taken back.

For J.K.SYSTEMS

E.&O.E.

Second Sales

(Signature)
 Manager



ST. ANNE'S COLLEGE OF ENGINEERING AND TECHNOLOGY

(Approved by AICTE, New Delhi. Affiliated to Anna University, Chennai)

ANGUCHETTYPALAYAM, PANRUTI – 607 106.

2. Oracle Server:

The screenshot shows the Oracle SQL Developer interface. On the left, a tree view displays the 'Municipality' schema with a list of tables. The 'SERVICE' table is selected. On the right, the 'Table: Municipality.SERVICE' view is displayed, showing the following data:

SERVICED	DESCRIPTION
1	1 Water Consumption
2	2 Electricity Consumption
3	3 Basic Electricity
4	4 Refuse Removal
5	5 Basic Sewerage
6	6 Sewerage Additional



ST. ANNE'S COLLEGE OF ENGINEERING AND TECHNOLOGY

(Approved by AICTE, New Delhi. Affiliated to Anna University, Chennai)
ANGUCHETTYPALAYAM, PANRUTI – 607 106.

DESIGNING SOFTWARES



ST. ANNE'S COLLEGE OF ENGINEERING AND TECHNOLOGY

(Approved by AICTE, New Delhi. Affiliated to Anna University, Chennai)

ANGUCHETTPALAYAM, PANRUTI – 607 106.

1.Latex:

The screenshot displays the LaTeX Editor (Led) interface. The main window shows a document titled "sc.tex" with the following content:

```
nationality suffixes:
\(\eg(-an), \eg(-e),\allowbreak) \eg(-can), \eg(-er), \eg(-ese),
\eg(-i), \eg(-ian)\}, adjective and adverb suffixes:
\(\eg(-al), \eg(-ar), \eg(-ic), \eg(-ical), \eg(-ed),
\eg(-ive)\}, \(\eg(-al), \eg(-ly),\allowbreak) \eg(-ally)\}.
Sample rules addressing vocabulary incompetence errors are shown
in Figure-\ref{fig:rules}.
```

The document also includes a sub-section titled "Gathering it all together" and a "LaTeX Font Warning" message: "Some font shapes were not available, defaults substituted".

On the right side, a diagram titled "Checking spelling errors by searching their causes" shows a flowchart with the following steps: "Word" → "Verification" → "Thought word" → "Spelling" → "Typing" → "Typed word".

Below the diagram, the text discusses the challenges of checking spelling errors and the need for a maximal cost of suggestion acceptance. It also mentions the use of a heuristic approach to generate a list of suggestions.

The bottom status bar indicates "Row 523, Col 1 Page 3 of 17".



ST. ANNE'S COLLEGE OF ENGINEERING AND TECHNOLOGY

(Approved by AICTE, New Delhi. Affiliated to Anna University, Chennai)

ANGUCHETTYPALAYAM, PANRUTI – 607 106.

2. Photoshop:

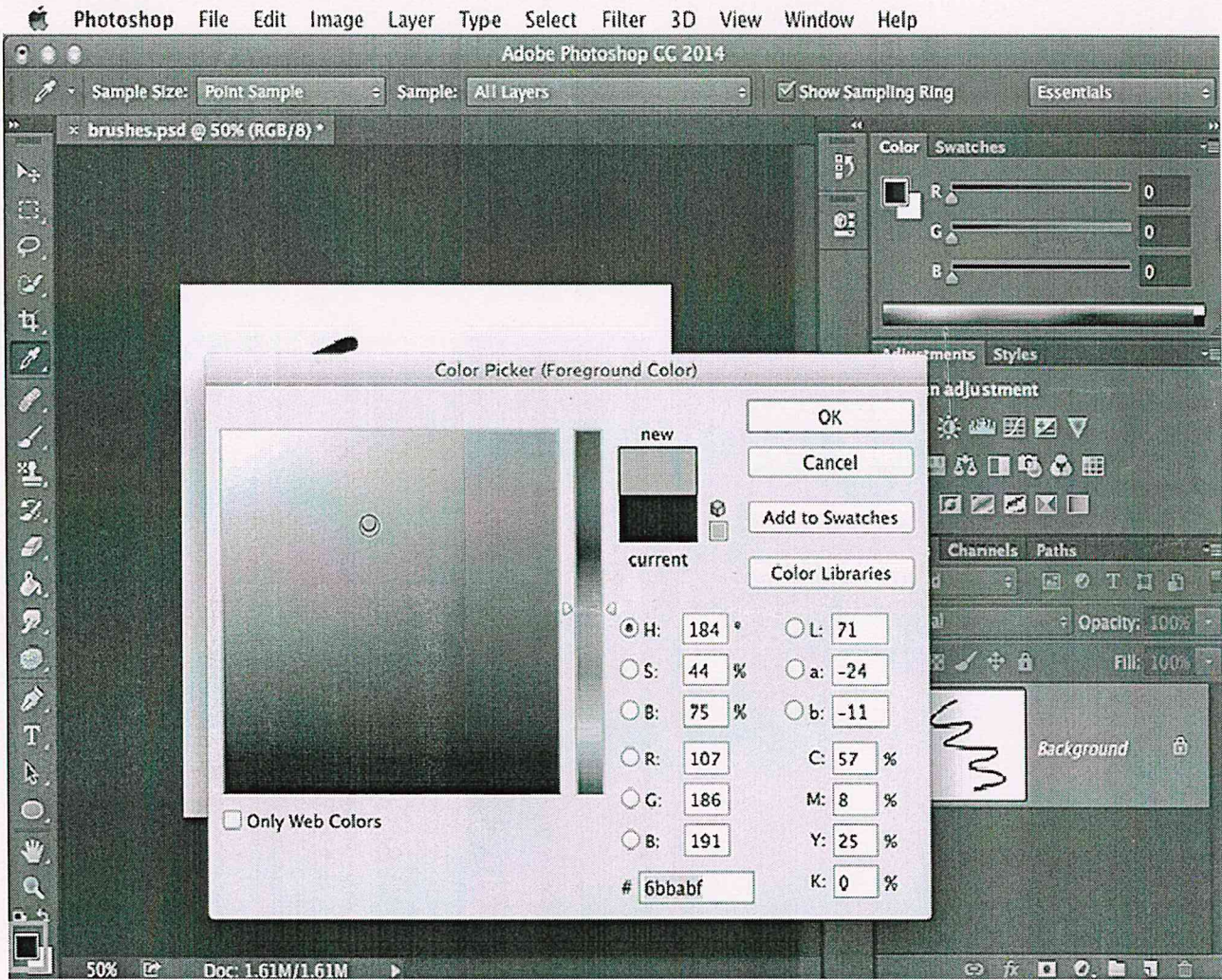



ST. ANNE'S COLLEGE OF ENGINEERING AND TECHNOLOGY
(Approved by AICTE, New Delhi. Affiliated to Anna University, Chennai)
ANGUCHETTYPALAYAM, PANRUTI - 607 106.

DEPARTMENT OF ECE



PURCHASED SOFTWARES

1. Tanner 16.0

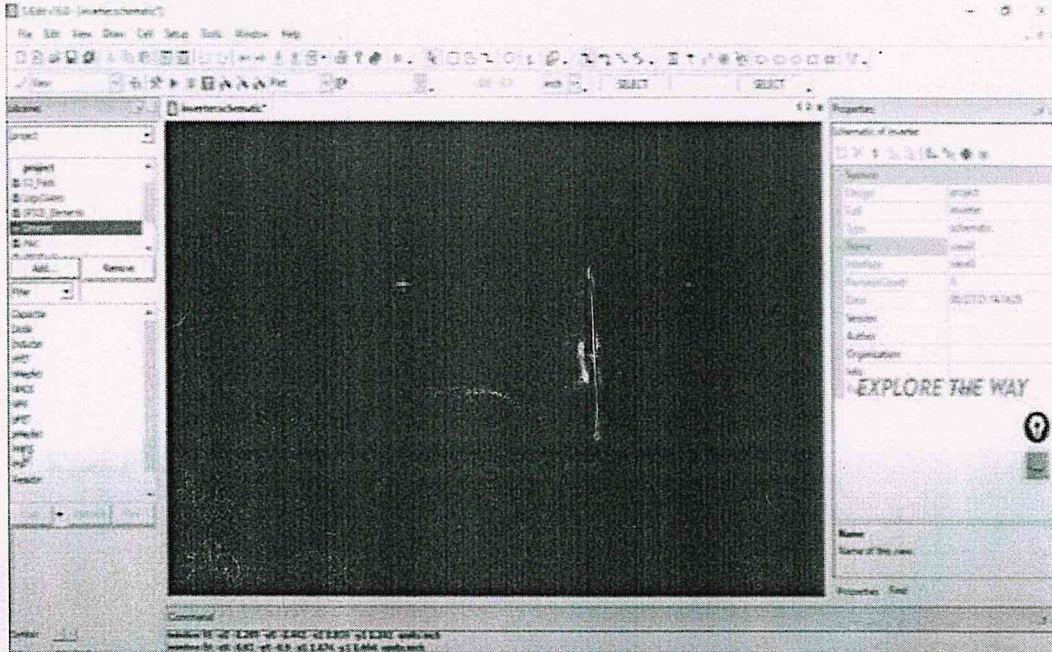

2. ORCAD 16.0

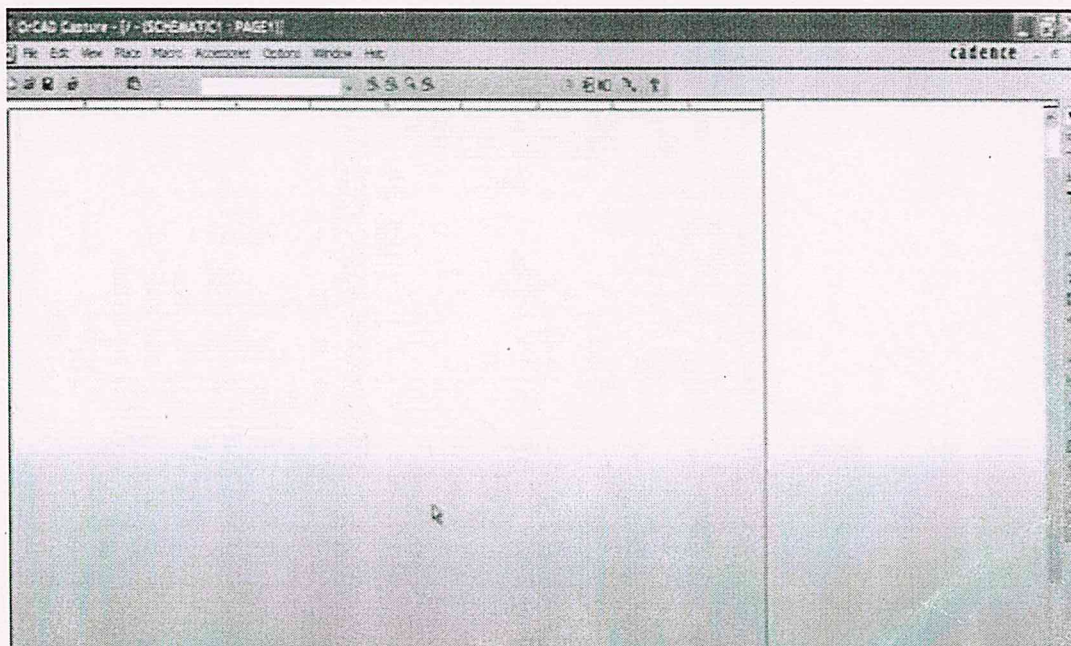

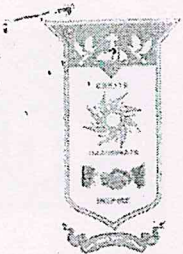

ST. ANNE'S COLLEGE OF ENGINEERING AND TECHNOLOGY

(A Unit of the Sisters of St. Anne, Trichirapalli.)

Anguchettypalayam, Siruvathur Post, Panruti Taluk - 607 110. Cuddalore District.

Phone : 04142 - 242661, 243661

Email id : stannescet@gmail.com

Lr. From AICTE File No. 07/08/TN/E&T/2009/20

PRINCIPAL

Purchase order No: SACET / ECE /03/12-13

Date: 17-12-2012

To:

The Manager,
FTD AUTOMATION PVT LTD,
KORAMANGALA,
BANGALORE.

Sir,

Kindly refer your Quotation NO: FTDAPL/SACET/029 dated 12.02.2012 and register this order to supply it immediately with the terms and Conditions as below.

S. No.	Particulars	Qty	Amount (Rs.)
1	OrCAD Simulation University Suite Version 16.6 consists of OrCAD Capture, OrCAD CIS Option, OrCAD PSPice A/D, OrCAD PSPice Advanced Analysis, OrCAD SLPS Option	10 User License	4,00,000.00
	CST 5%		20,000.00
Total			4,20,000.00

Yours Sincerely

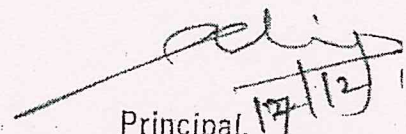
Principal, 17/12/12
St. Anne's College of Engineering & Technology,
ANGUCHETTYPALAYAM,
Siruvathur-Post, Panruti-T.k.,
Cuddalore-Dist, 607 110

**TAX INVOICE**No. FTDAPL/CAD/2012-13/127
Date: 24.12.20012

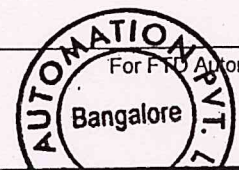
Bill To: THE PRINCIPAL ST.ANNE'S COLLEGE OF ENGINEERING AND TECHNOLOGY, Anguchettyalaym, Siruvathur Post, Panruti Taluk- 607110 . Cuddalore District.	Ship To: THE PRINCIPAL ST.ANNE'S COLLEGE OF ENGINEERING AND TECHNOLOGY, Anguchettyalaym, Siruvathur Post, Panruti Taluk- 607110 . Cuddalore District.		
Your VAT TIN: Your CST No.:	Your PO No.: SACET/ECE/03/12-13 PO Date : 17/12/2012		
Our PAN No. AABCF7486R Our TAN No. BLRF02274G Our VAT TIN No. 29150629799 Our CST No. 29150629799 Service Tax No. AABCF7486RSD001 IEC Code No. 711016771	Our Contact Person Sanjay Phone No.LandLine 91-80-42600900 To 999 Phone No.Cell Your Contact Person Phone No.LandLine Phone No.Cell		
PARTICULARS	QUANTITY	RATE	AMOUNT -INR
OrCAD Simulation University Suite Version 16.6 Consists of : OrCAD Capture, OrCAD CIS Opaton, OrCAD Pspice, A/D, OrCAD Pspice Advanced Analysis, OrCAD SLPS Option Add: CST@ 5%	10 License	4,00,000.00	4,00,000.00
			20,000.00
Rupees in Words: Four Lakh Twenty Thousand Only		Total	INR 4,20,000.00
TERMS Payment through At Par Cheque/s favouring 'FTD Automation Private Limited'. For Bank Fund Transfer please use the info provided below:- 2. Terms of Payment: 100% Against Delivery 3. Discrepancies in this invoice should be intimated immediately and not later than 7 days from the date of the invoice Information For ECS/NEFT/RTGS - Direct Fund Transfer to our Bank Account: Beneficiary Name FTD Automation Private Limited Bank & Branch HDFC Bank, Koramangala Branch, Bangalore Current Account N. 00532320004618 IFSC Code No. HDFC0000053 MICR Code No. 560240004			
		 For FTD Automation Private Limited Authorized Signatory	

FTD Automation Pvt. Ltd.

7, 1st Floor, 100ft Road, 17th Main, 5th Block, Koramangala, Bangalore - 560 095. INDIA
Phone No: +91-80-42600900 Fax No: +91-80-25506776. Email ID: sales@ftdautomation.com

Terms & Conditions

1. Deliverables: CD Containing software, license files and hardware lock. Only online manuals are available.
2. The present latest version is 16.6
3. All Quoted Products are Floating and Perpetual/ 99 Years in nature.
4. Floating License: Floating License enables you to invoke the software on any suitable Computer connected within Network Environment but number of invocations is limited to the user license of Cadence/OrCAD software purchased. For example if you purchase one user license, then you can invoke the software at any given point of time once at a time on the machine connected within the Network Environment.
5. Updates: The product cover 1 year maintenance from the date of Purchase order. During maintenance you are eligible to receive free updates as and when released by Cadence for the product you purchase.
6. Delivery: 4 weeks from the date of technically and commercially clear order.
7. Payment: 100% Advance as we pay 100% upfront to our Principals.

Yours Sincerely

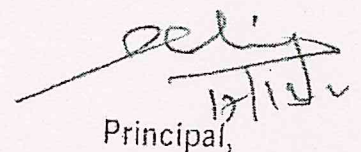

Principal,

St. Anne's College of Engineering & Techno
ANGUCHETTPALAYAM,
Siruvathur-Post, Panruti-T.k.,
Cuddalore-Dist, 607 110.

RETAIL INVOICE / CASH MEMO / BILL

TRIDENT TECHLABS PVT.LTD. White House, IInd Floor, 1/18-20, Rani Jhansi Road, New Delhi-110 055 Ph. No. 91-11-23629285,23629286, Fax 91-11-23629287 Regd. Office : - A-19, Saraswati Garden, New Delhi - 110015 E-Mail : accounts@tridenttechlabs.com	Invoice No.	Dated
	273/2013-14	31-Mar-2014
	Delivery Note	Mode/Terms of Payment
	Supplier's Ref.	Other Reference(s)
Buyer St. Anne's College of Engineering & Technology Anguchettypalayam, Siruvathur Post, Panruti Taluk - 607110 Cuddalore District	Buyer's Order No.	Dated
	SACET/ECE/06/13-14	20-Mar-2014
	Despatch Document No.	Dated
	Despatched through	Destination
Terms of Delivery		

SI No.	Description of Goods	Quantity	Rate	per	Amount
1	Tanner Software (St. Anne's) Batch : 80-2896E 1. Tanner Software 16 User - Hiper Simulation (5 User) Consist of S - Edit, W- Edit T-Spice & Verilog -A. - L - Edit & DRC (5 User) Consists of L - Edit Base , DRC Std, Interactive DRC Dev Gen, SDL -Hiper Verify (5 User) Consists of LVS Std, Extract Std SFR, Node Hglighting, DXF, PadMap Parasitics Extraction (1 User) 16 User @ 10 User Cost (Perpetual License) (1 Set of 16 User)	1 Nos. 1 Nos.	6,00,000.00	Nos.	6,00,000.00

continued ...

This is a Computer Generated Invoice

Chennai @ tridenttechlabs.co



ST. ANNE'S COLLEGE OF ENGINEERING AND TECHNOLOGY

(Approved by AICTE, New Delhi. Affiliated to Anna University, Chennai)

ANGUCHETTYPALAYAM, PANRUTI - 607 106.

Purchased Software

MATLAB 10

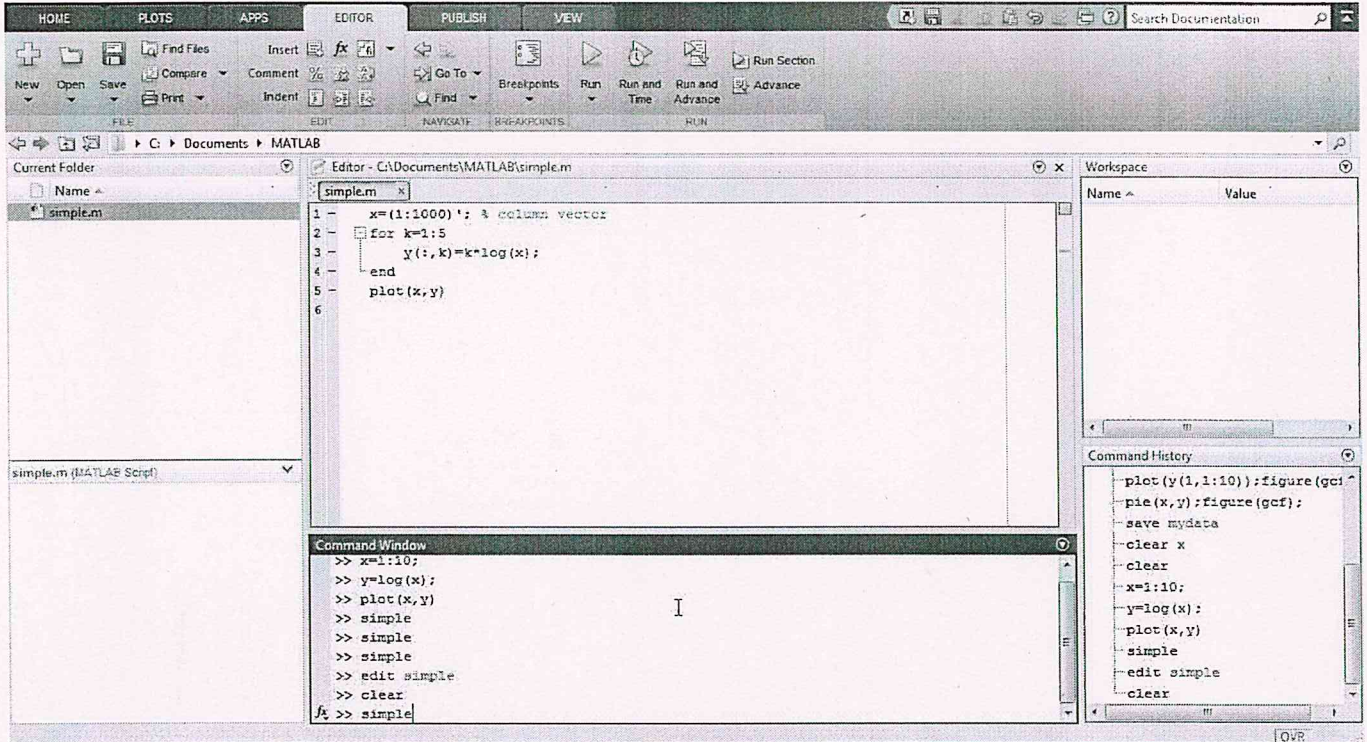

Xilinx ISE 12.1

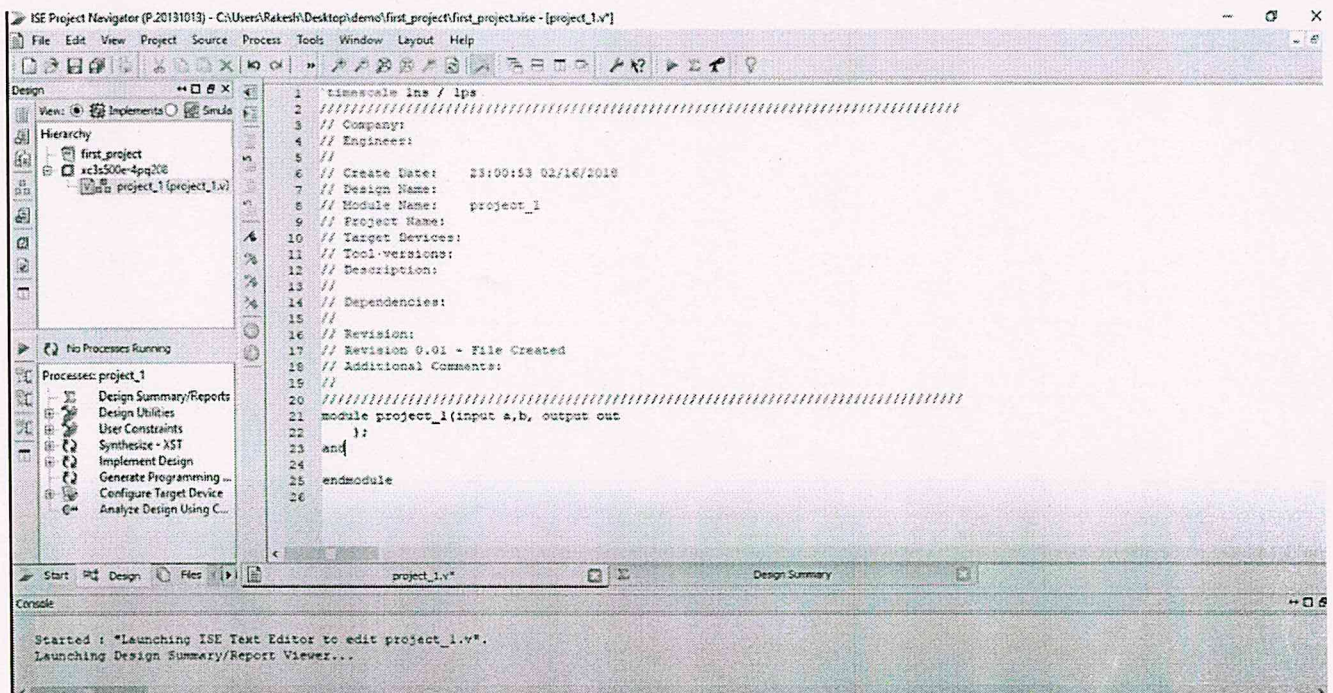

TAX INVOICE

Bill to ST ANNEs COLLEGE OF ENGINEERING AND TECHNOLOGY Anguchettypalayam, Siruvathur Post, Panruti Taluk-607110	Invoice No. DST/2010-11/394	Dated 30-Mar-2011
	Purchase Order No. SACET/ECE/02/11-12	Purchase Order Date 23-Mar-2011
	Delivery Note NA	Mode/Terms of Payment 100% Advance
Shipped to ST ANNEs COLLEGE OF ENGINEERING AND TECHNOLOGY Anguchettypalayam, Siruvathur Post, Panruti Taluk-607110	Shipped Date	Buyers TIN NA
	Price Basis Purchase Order	Remarks

#	Particulars	Quantity	Rate	Amount
1	MATLAB(MALL)	15	16,100.00	241,500.00
2	SIMULINK (ALL)	15	8,050.00	120,750.00
3	Control system tool box	05	8,855.00	44,275.00
4	Sim Power	15	16,100.00	241,500.00
5	Signal Processing Tool Box	05	8,855.00	44,275.00
6	Sim Hydraulics	05	8,855.00	44,275.00
7	Sim Neumatics	05	8,855.00	44,275.00
8	Sim Scape	05	8,855.00	44,275.00
SUB TOTAL				825,125.00
CST @ 5%				41,256.00

Total Amount INR 866,381.00

Amount in words

INR Eight Lakh Sixty Six Thousand Three Hundred Eighty One Only

K.S.T No. : 90207907
C.S.T No. : 90257900
VAT TIN : 29600080386
Service Tax : AABCC1915EST001
PAN No. : AABCC1915E

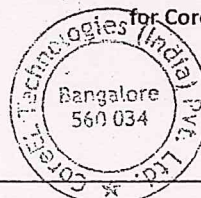

for CoreEL Technologies (I) Pvt. Ltd.

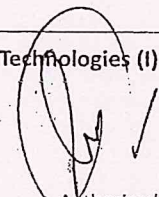
 Authorised Signatory



St. Anne's College Engineering & Technology <stannescet@gmail.com>

Xilinx, Inc. – License File for Your Software or IP Core Productxilinx.notification@entitlenow.com <xilinx.notification@entitlenow.com>
To: stannescet@gmail.com

Mon, Jan 10, 2011 at 1:02 PM

Dear ganapathy:

Thank you for licensing your Xilinx® software or IP core product. This email confirms your product registration and includes the license file to enable your product.

The license file can also be obtained by returning to the Xilinx Product Licensing Site:

<http://www.xilinx.com/getlicense>

For complete instructions on installing this license file, see the ISE Design Suite 12: Installation, Licensing, and Release Notes document on the Xilinx web at:

English: http://www.xilinx.com/ise/notes_eJapanese: http://www.xilinx.com/ise/notes_j

Quick-Start License Installation Instructions

Node-locked Licenses:

These steps will copy your license file to the appropriate default directory (the .Xilinx directory under your home drive - typically HOMEDRIVE= C: for Windows).

1. Save the attached license file to your desktop or some other folder on your computer
2. Run the Xilinx License Configuration Manager
Windows: Run 'Manage Xilinx Licenses' from Xilinx ISE Design Suite 12 program group
Linux: Type 'xlcm' in a command-line window
3. Select the 'Manage Xilinx Licenses' tab and click on the 'Copy License...' button
4. Browse to the downloaded license file and click 'Open'

Note: IP licenses generated from the Xilinx Product Licensing Site are designed to be used with both ISE Design Suite 12, 11 and 10.1 IP. If IP licenses are to be used with a 10.1 ISE Design Suite software installation, the license file should be copied to .Xilinx\Coregen\CoreLicenses. ISE 10.1 software looks in this location for IP licenses.

Floating Licenses:

- If you have an existing FLEXnet floating license server, it may be easiest to simply copy the license keys in the attached file into the license file you are already using with your license server

Note: Please restart your floating license server to allow the changes to take effect

- If you are setting up a FLEXnet floating license server for the first time, please see the ISE Design Suite 12: Installation, Licensing, and Release Notes for more detailed directions

Support Information

For questions regarding products within your Product Entitlement Account or if you feel you have received this notification in error, send an email to your regional Customer Service Representative:

Canada, USA and South America - isscs_cases@xilinx.comEurope, Middle East, and Africa - eucases@xilinx.comAsia Pacific including Japan - apaccase@xilinx.comFor technical support including the installation and use of your product license file you may contact Xilinx Online Technical Support at www.support.xilinx.com. On this site you will also find the following resources for assistance:Software, IP and Documentation Updates
Access to Technical Support Web Tools
Searchable Answer Database with Over 4,000 Solutions
User Forums

Regards,

Xilinx Customer Service

This email was sent by:

Xilinx, Inc.

2100 Logic Dr.

San Jose, CA 95124-3400

United States of America

Xilinx does not rent, sell or lease customer information. We respect your right to privacy. View our policy at

www.xilinx.com/legal.htm.

S(eula)

 Xilinx.lic
1K



enter keywords
Advanced Search

Home : Support : Product Licensing

Product Licensing

Account: **ST. ANNE S COL. OF ENGG AND TECH - T. GANAPATHY 3832**



Create New Licenses | Manage Licenses | Manage Users | Legacy Licensing

Manage License Files for Account: ST. ANNE S COL. OF ENGG AND TECH

Host Name	Host Type	Host ID	License Type	OS	Created By	Created Date
ECESERVER	Ethernet MAC	6CF049F567B1	Floating	Windows 32-bit	ganapathy t	10 JAN 2011

ECESERVER 6CF049F567B1 Floating ganapathy t 10 JAN 2011

Comments

Product	Type	Status	Subscription End Date	Activated Seats
ISE Design Suite - Logic E...	Full	Current	30 Sep 2011	25



M





St. Anne's College Engineering & Technology <stannescet@gmail.com>

Confirmation of ISE Design Suite 12: 12.4 Installation DVD Order

Xilinx, Inc. <CS_1@xilinx.com>
To: stannescet@gmail.com

Mon, Jan 10, 2011 at 2:16 PM

This email is a confirmation of the order you recently placed with Xilinx, Inc. A shipment email with the ship date will be sent to you when your product has shipped.

Order Information:
=====

Order ID: 23207
Date/Time Placed: Monday, January 10, 2011 - 3:46:37 AM
Total Order Cost: \$0.00

Product Information:
=====

Product Code: ISE-Design-Suite-12
Product Title: ISE Design Suite 12: 12.4 Installation DVD
Quantity: 1
Cost: \$0.00

Cart Total: \$0.00

Shipping Information:
=====

ST ANNES COLLEGE OF ENGINEERING AND TECHNOLOGY
Mr. The Principal
anguchettyalayam
SIRUVATHUR POST, PANRUTI
CUDDALORE DISTRICT, Tamilnadu 607110
IN

Shipping Method: noCharge

Thank you again for ordering from Xilinx.



enter keywords
Advanced Search

Home : Support : Product Licensing

Product Licensing

Account:

Help

[Create New Licenses](#) | [Manage Licenses](#) | [Manage Users](#) | [Legacy Licensing](#)

Have a Voucher to Redeem?

XXXX-XXXXXX-XXXX-XXXXXX

[Redeem Now](#)

Evaluation and No Charge Cores

Search the Evaluation and No Charge cores catalog and add specific cores to table below [Search Now](#)

Create a New License File for Account: ST. ANNE S COL. OF ENGG AND TECH

Create a new license file by making your product selections from the table below. Floating and Node-Locked licenses cannot be combined in the same license file.

Product	Type	License	Available Seats	Status	Subscription End Date
ISE Design Suite: 30-Day Evaluation, Node-Locked License	Evaluation	Node	1/1	Current	30 days
ISE Design Suite: WebPACK License	No Charge	Node	1/1	Current	None

[Generate Floating License](#) | [Generate Node-Locked License](#)

[What is the difference between a floating and a node license?](#)





Open Source Software:

1. ESIM 2.3:

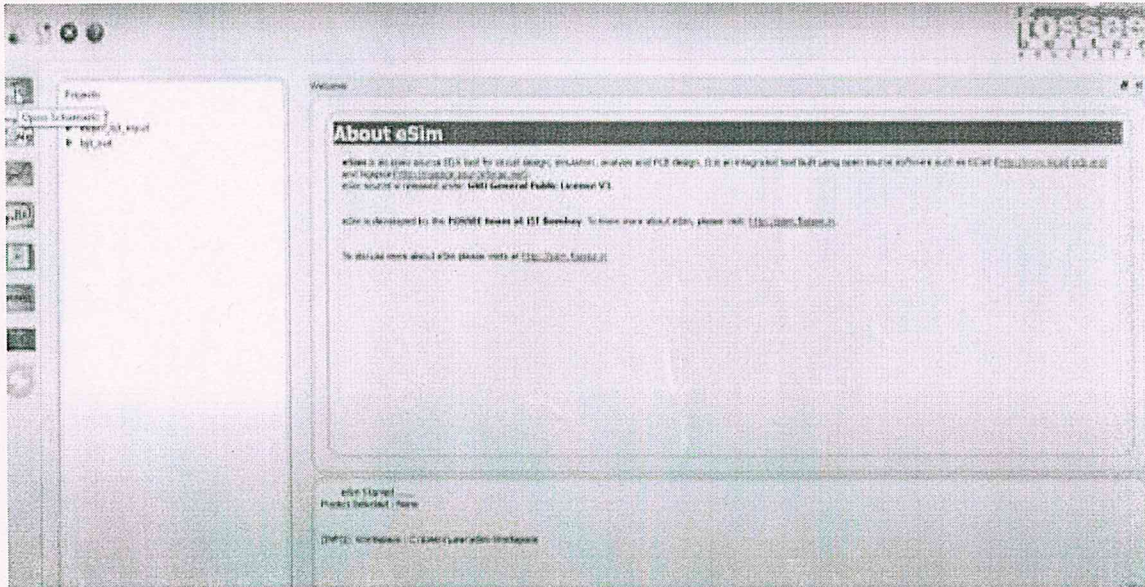

2. Ansys HFSS-2015

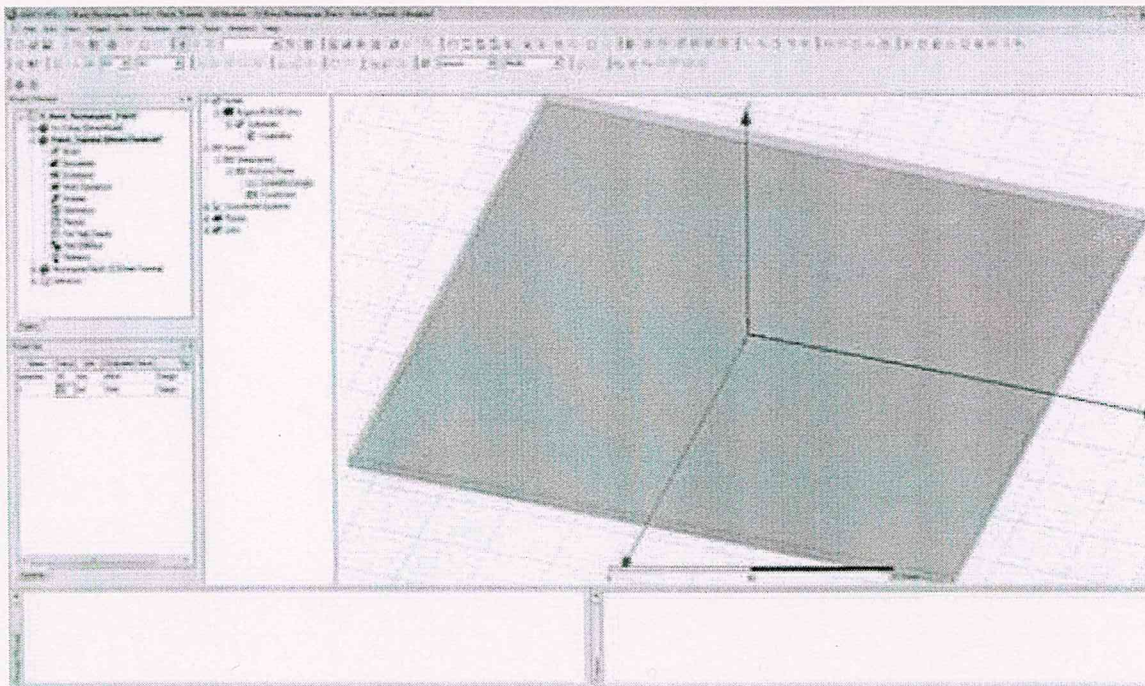



ST. ANNE'S COLLEGE OF ENGINEERING AND TECHNOLOGY
(Approved by AICTE, New Delhi. Affiliated to Anna University, Chennai)
ANGUCHETTYPALAYAM, PANRUTI – 607 106.

3. Proteus 8.6

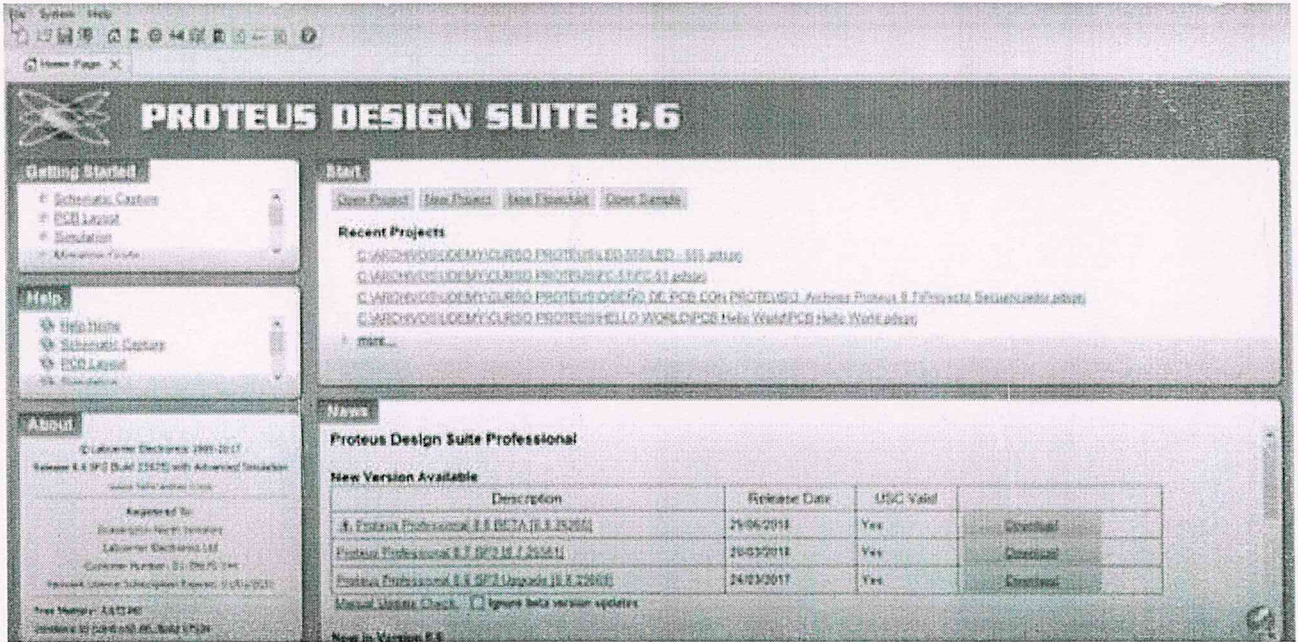

4. Multisim 8.0

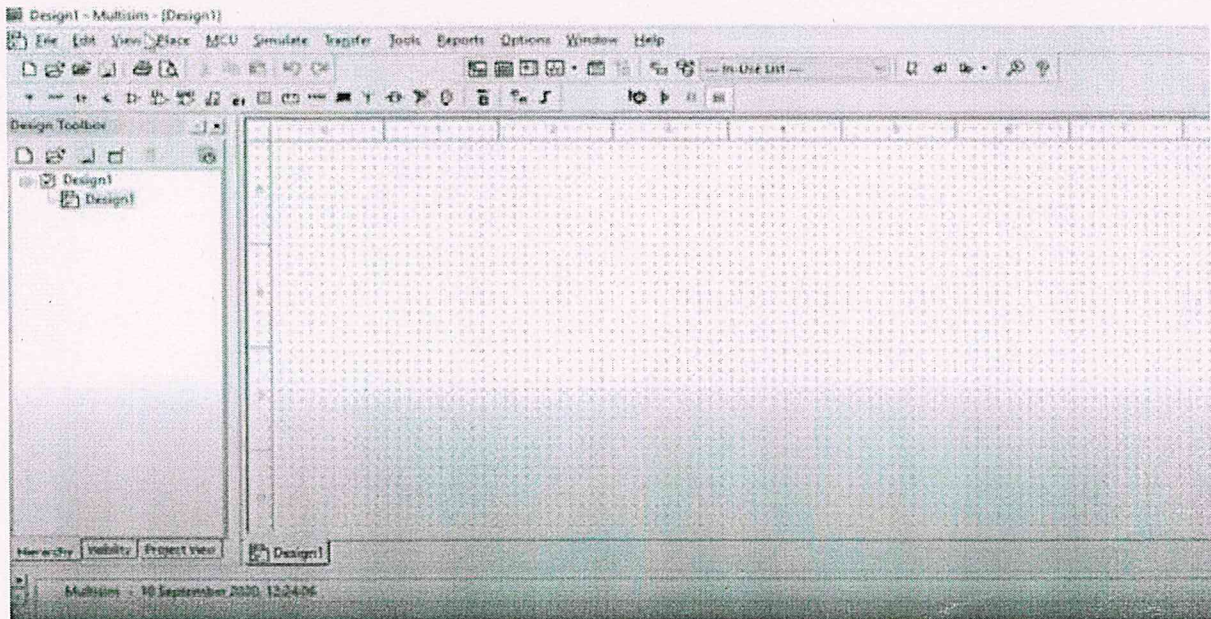



ST. ANNE'S COLLEGE OF ENGINEERING AND TECHNOLOGY

(Approved by AICTE, New Delhi. Affiliated to Anna University, Chennai)
ANGUCHETTYPALAYAM, PANRUTI – 607 106.

Open source Softwares

SCILAB 6.1.1

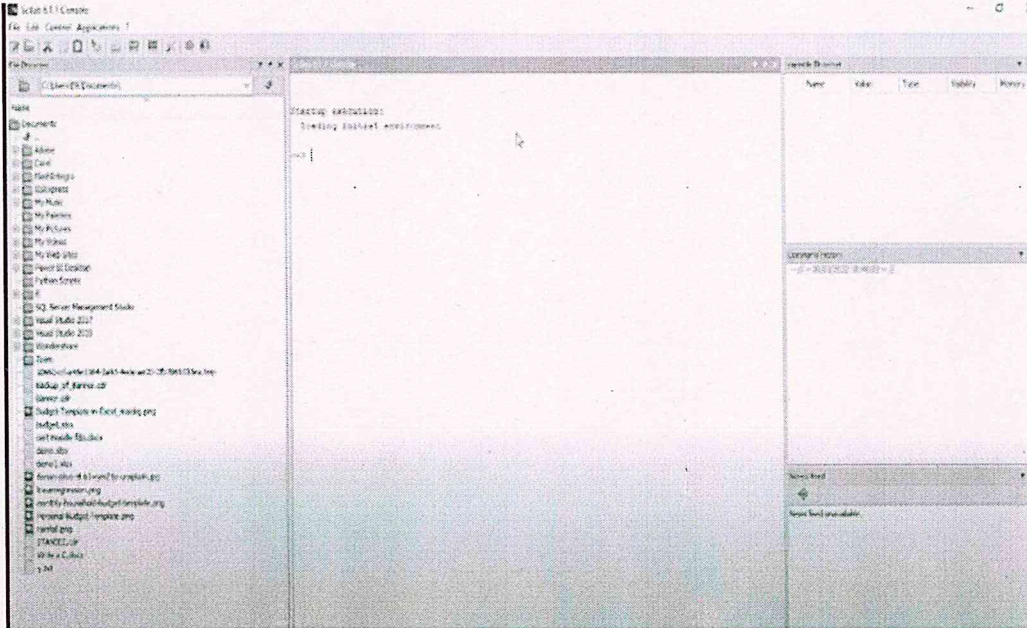

Arduino IDE 2.0:

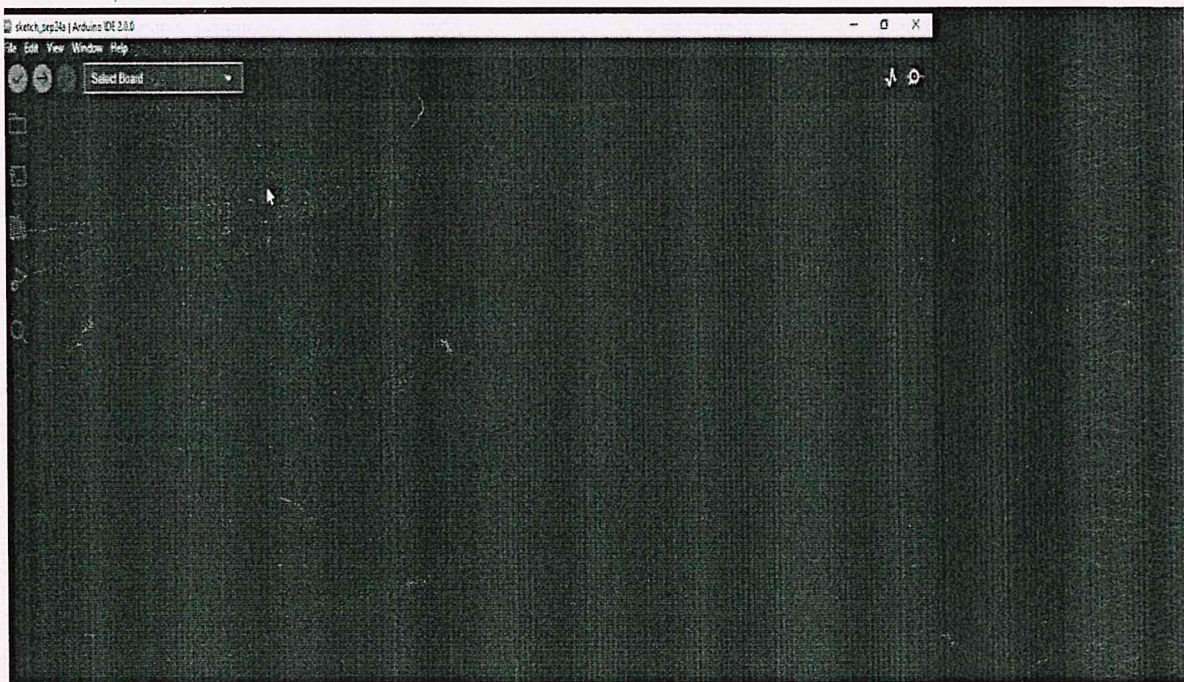



ST. ANNE'S COLLEGE OF ENGINEERING AND TECHNOLOGY

(Approved by AICTE, New Delhi. Affiliated to Anna University, Chennai)

ANGUCHETTPALAYAM, PANRUTI - 607 106.

MASM for 8086

```
.MODEL SMALL
.STACK 64
.DATA
.CODE
START: MOV AX, @DATA
        MOV DX, AX
        MOV AL, 01H
        MOV BL, 02H
        ADD AL, BL
        MOV SI, 3000H
        MOV [SI], AL
        MOV AH, 4CH
        INT 21H
        END START
.END
```

KEIL IDE V3.0&4.0

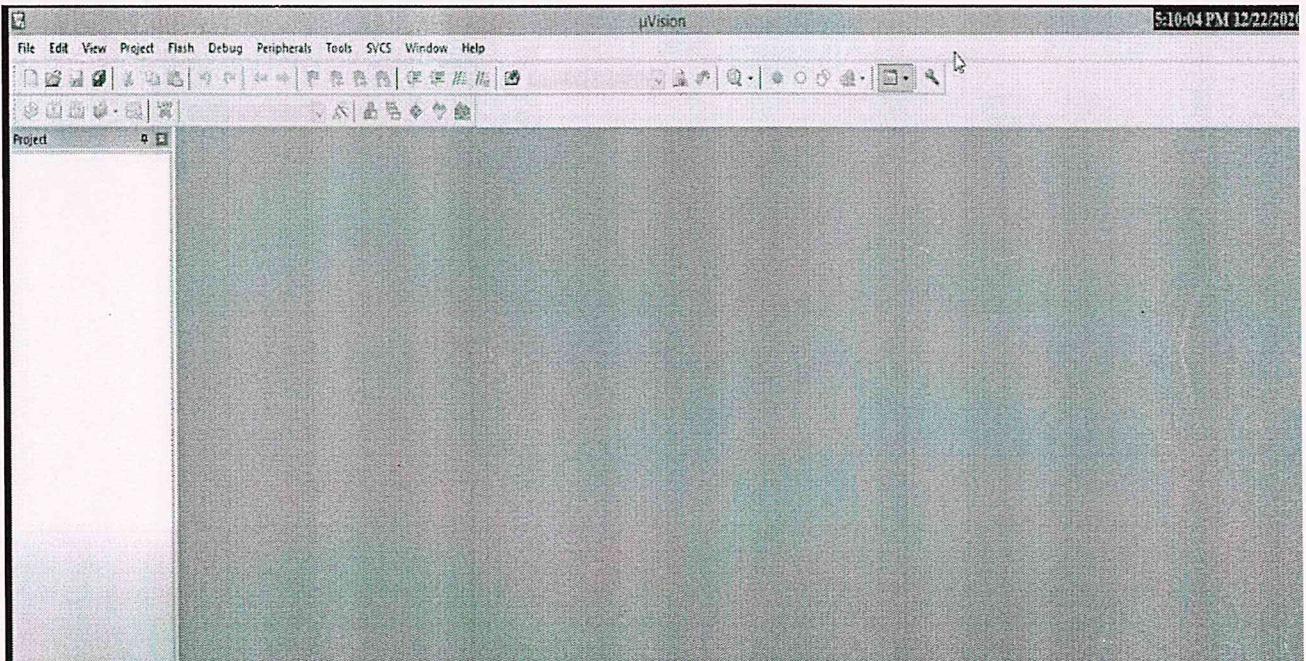



ST. ANNE'S COLLEGE OF ENGINEERING AND TECHNOLOGY

(Approved by AICTE, New Delhi. Affiliated to Anna University, Chennai)

ANGUCHETTYPALAYAM, PANRUTI - 607 106.

Python

```
Python 3.10.0 (tags/v3.10.0:b494f59, Oct 4 2021, 19:00:18) [MSC v.1929 64 bit (AMD64)] on win32
Type "help", "copyright", "credits" or "license()" for more information.
>>> print("Amit Thinks...")
Amit Thinks...
>>>
```

FLASH MAGIC

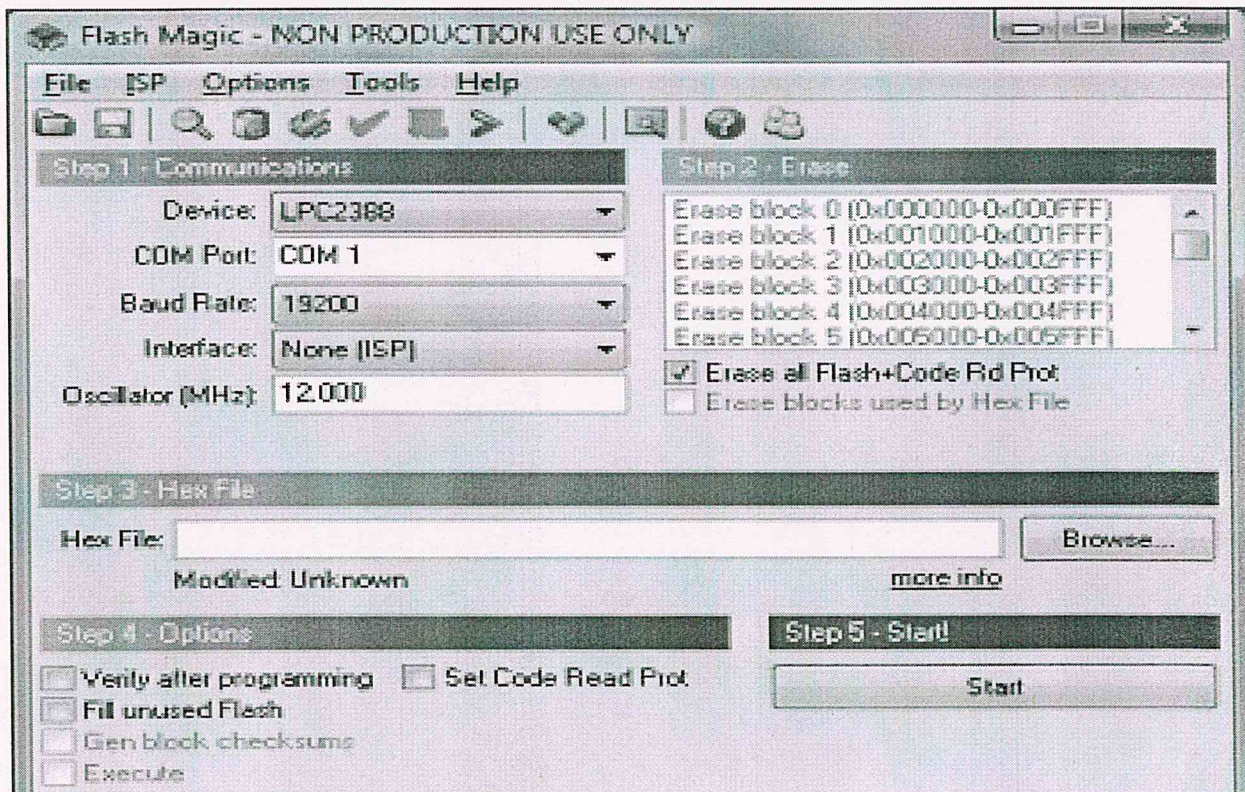



ST. ANNE'S COLLEGE OF ENGINEERING AND TECHNOLOGY
(Approved by AICTE, New Delhi. Affiliated to Anna University, Chennai)
ANGUCHETTYPALAYAM, PANRUTI – 607 106.

DEPARTMENT OF EEE



ST. ANNE'S COLLEGE OF ENGINEERING AND TECHNOLOGY
(Approved by AICTE, New Delhi. Affiliated to Anna University, Chennai)
ANGUCHETTYPALAYAM, PANRUTI – 607 106.

1. MI Power version 10.0

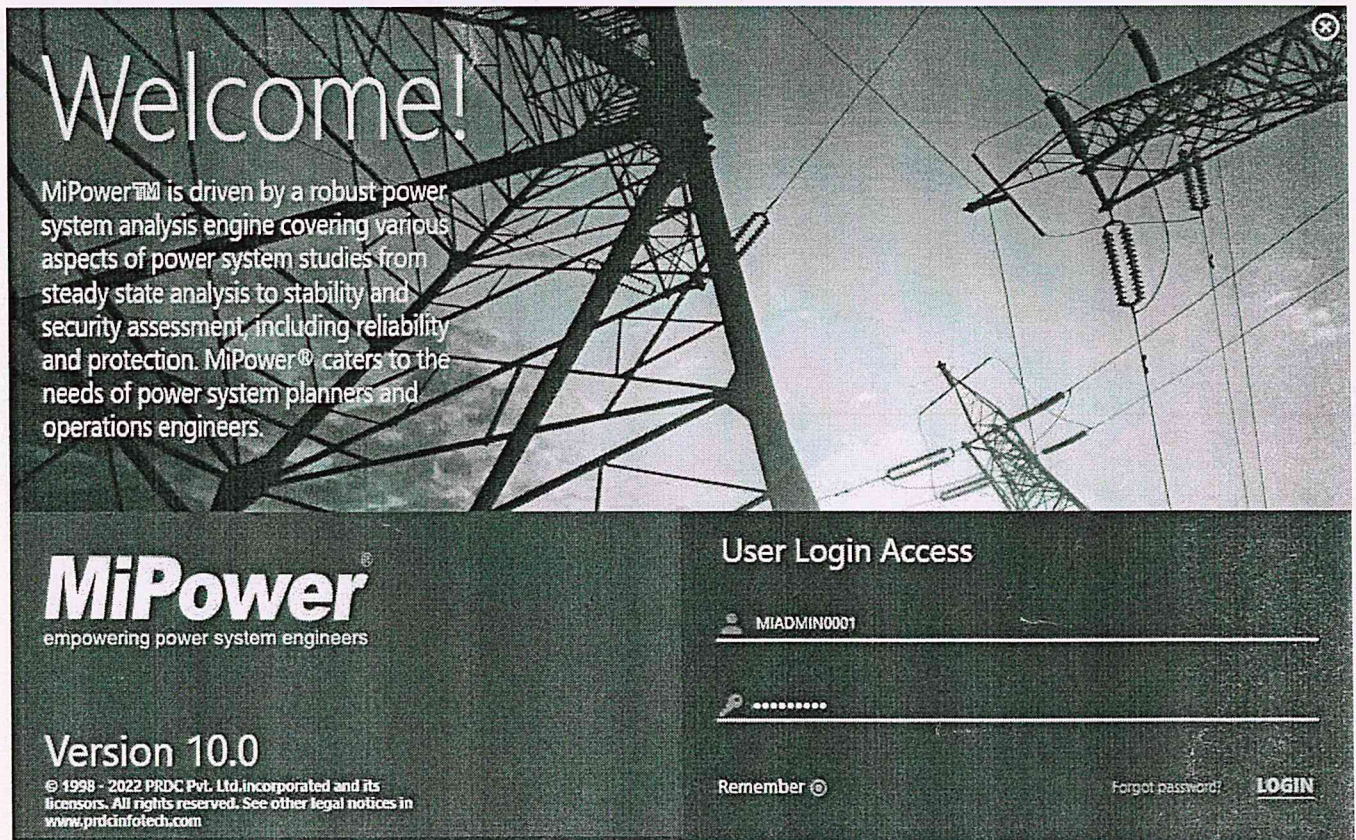
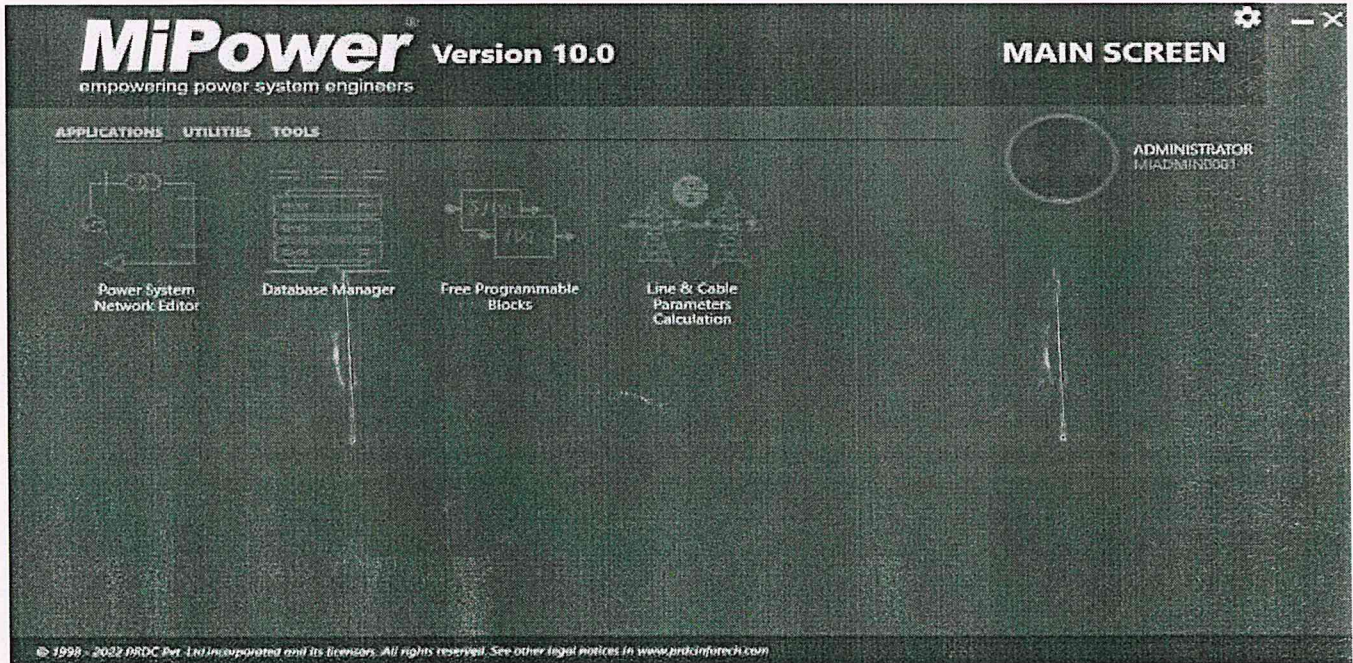

Ref: V11/QTN/4414C

Dated : 25-Jun-2012

**THE PRINCIPAL,
ST. ANNE S COLLEGE OF ENGINEERING & TECHNOLOGY,
ANGUCHETTYPALAYAM,
SIRUVATHUR POST,
PANRUTI TALUK,
CUDDALORE - 607 110.**

Kind Attn. : HOD OF EEE DEPARTMENT

Dear sir,

As desired by you, we are pleased to enclose our **QUOTATION** for your favourable consideration.

We believe that you will find our offer as quite attractive and cost effective to your needs. In case you require any further clarifications or details please do feel free to contact us.

Looking forward to receive your valuable order.

Thanking you and assuring of our best services.

**Yours faithfully,
For Vi Microsystems Pvt. Ltd.,**

Dy MANAGER MARKETING

MIPOWER SIMULATION SOFTWARE**1. Specification (100 Node limited edition)**

MiPower package as per Anna University Syllabus	No of Users	Price in Rs.
<ul style="list-style-type: none"> * Load-Flow Analysis * Line & Cable Parameter Calculation * Short - circuit study * Transient Stability (with Motor Starting) * Voltage Instability Analysis * Electromagnetic Transient Analysis * Mi Power – Tools 	1. Single User	2,57,140.00 + Taxes
	2. 5 Net Users	3,09,310.00 + Taxes
	3. 10 Net Users	3,74,540.00 + Taxes
	4. 15 Net Users	4,39,750.00 + Taxes
	5. 20 Net Users	5,04,960.00 + Taxes
	6. 30 Net Users	6,35,400.00 + Taxes
	7. 40 Net Users	7,65,840.00 + Taxes
	8. 50 Net Users	8,96,280.00 + Taxes

2. Specification (Unlimited edition)

MiPower package as per Anna University Syllabus	No of Users	Price in Rs.
<ul style="list-style-type: none"> * Load-Flow Analysis * Line & Cable Parameter Calculation * Short - circuit study * Transient Stability (with Motor Starting) * Voltage Instability Analysis * Electromagnetic Transient Analysis * Mi Power – Tools 	1. Single User	2,81,360.00 + Taxes
	2. 5 Net Users	4,30,430.00 + Taxes
	3. 10 Net Users	6,16,775.00 + Taxes
	4. 15 Net Users	8,03,110.00 + Taxes
	5. 20 Net Users	9,89,450.00 + Taxes
	6. 30 Net Users	13,62,220.00 + Taxes
	7. 40 Net Users	17,34,815.00 + Taxes
	8. 50 Net Users	21,07,490.00 + Taxes

Terms & Conditions

01	Taxes	Extra Service tax @ 10.3 % & CST @ 5 %
02	Validity of offer	60 Days from the date of quotation
03	Terms of payment	100% Advance along with Order
04	Mode of payment	Demand Draft (DD) in favour of " Power Research and Development Consultants Pvt Ltd " Payable at Bangalore or Electronic fund transfer (RTGS)
05	Delivery	With in two Weeks from the date of receipt of techno – commercial clear and firm purchase order.
06	Warranty	This offer covers one year free warranty. Under free warranty support period technical support can be utilized over phone / fax / email on all working days. Minor software updates & bug fixes are supplied on CD media by courier absolutely free of cost.
07	Annual Maintenance Charges (AMC)	After expiry of warranty period 10 % will charge for one year.
08	Packing & Forwarding	Paid by PRDC – Bangalore
09	Installation	Free of cost
10	Demonstration & Training	2 Days at the college campus premises is FREE.

Note: The Order should be placed in the name of our principal

" Power Research & Development Consultants Pvt ltd,
#5, 11th Cross, 2nd Stage, West of Chord Road,
BANGALORE-560 086

Thanking You

For Vi Microsystems Pvt Ltd.,

Deputy Manager Marketing



ST. ANNE'S COLLEGE OF ENGINEERING AND TECHNOLOGY

(A Unit of the Sisters of St. Anne, Trichirapalli.)

Anguchettypalayam, Siruvathur Post, Panruti Taluk - 607 110. Cuddalore District.

Phone : 04142 - 242661, 243661

Email id : stannescet@gmail.com

Lr. From AICTE File No. 07/08/TN/E&T/2009/20

PRINCIPAL

Date: 29.03.2012

Purchase order No: SACET / EEE/ 02/11-12

To:

Mohan Kumar.M.J,
Sr. Engineer – BD
#5, 11th Cross, 2nd Stage,
West of Chord Road,
Bangalore –560086,
INDIA.

Sir,

Kindly refer your quotation (Ref No: PRDC/2011-2012/SACET/1702) for Power System Simulation Software (MIPOWER) and please register this order.

S. No	PACKAGE	USERS	AMOUNT
1	MiPower™ Supporting 100 Nodes/Buses as Per Anna University Syllabus	30	Rs:4,63,858/-

**With the Discount of 15% on the quoted amount

Thanking you

Yours sincerely,

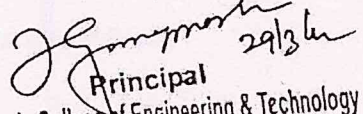
Principal
St. Anne's College of Engineering & Technology
ANGUCHETTYPALAYAM,
Siruvathur-Post, Panruti-T.k.,
Cuddalore-Dist, 607 110.

CLIENTS' COPY

POWER RESEARCH & DEVELOPMENT CONSULTANTS PVT. LTD

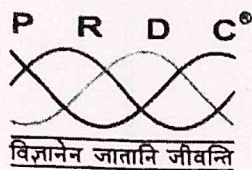

#5, 11th Cross, 2nd Stage, West of Chord Road,
Bangalore-86,

Ph No: +91-80- 23192159//23192209; Fax: +91-80-23192210
E-mail : prdc@vsnl.com; www.prdcinfotech.com

KST :71628873 }
CST :71678876 } dtd 6 - 5 - 95

DELIVERY CHALLAN

NO: 2011-2012/109

DATE: March 31, 2012

PURCHASER'S NAME & ADDRESS		SUPPLIER'S ADDRESS	
To St. Anne's College of Engineering and Technology Anguchettypalayam, Siruvathur Post, Panruti Taluk, Cuddalore District, - 607110, Tamil Nadu Phone: 04142 -242661, 243661, 241661, 242661 Fax: 04142-242661 and Attn.: HOD Of Electrical & Electronics Engineering		Power Research & Development Consultants Pvt. Ltd. #5, 11 th Cross, 2 nd Stage, WOC Road Bangalore - 560 086. INDIA Ph No: +91-80- 23192159//23192209; Fax: +91-80-23192210 Email: prdc@vsnl.com	
P.O. No : SACET/EEE/02/11-12	Dtd: 29-Mar-2012	Invoice/Credit Bill No.: 18428	Date: 30.03.2012

SL.NO.	ITEM DESCRIPTION	QTY IN NOS.	REMARKS
I	MiPower Software User Manuals		
	1. Load Flow Analysis	✓ 01	
	2. Short Circuit Study	✓ 01	
	3. Transient Stability	✓ 01	
	4. Free Programmable Blocks	✓ 01	
	5. Relay Coordination	00	
	6. Line & Cable Parameter Calculation	✓ 01	
	7. Dynamic Stability	00	
	8. Voltage Instability Analysis	✓ 01	
	9. Network Reduction	00	
	10. Harmonic Analysis	00	
	11. Long Term Demand Forecast	00	
	12. Sub Synchronous Resonance	✓ 01	
	13. Electro Magnetic Transient Analysis	✓ 01	
	14. Three Phase Load Flow Analysis	00	
	15. Ground Mat Design	00	
	16. Technical document	✓ 01	
	17. User Interface	✓ 01	
	18. Anna University Blue Book	✓ 01	
	19. How to solve manuals	✓ 05	
II	Installation Manual	✓ 01	
III	CD No. - MiPower- 6356-30	✓ 01	
IV	USB- Network Locks No.: 3974 - 1410	✓ 01	
V	Authenticity Certificate	✓ 01	
	TOTAL:	20	

SHIP MODE: HAND DELIVERY / ✓ COURIER / REG. POST

NOTE: Only ticked items are applicable.

for POWER RESEARCH & DEVELOPMENT CONSULTANTS PVT. LTD.,

Received by (Signature with Seal):

(Signature)
 EUGEN MARTIN RAJ
 L EOT/EEE



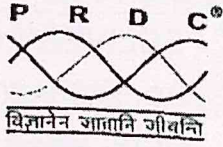

**Power Research & Development
Consultants Private Limited**

#6, 11th Cross, 2nd Stage, West of Chord Road, Bangalore 560008, INDIA
Phone: +91 - 80 - 4245-5555 / 2318-2209
Fax: +91 - 80 - 4246-5556 / 2318-2210
E-mail: prdc@vsnl.com Website: www.prdcinfotech.com

Ref No: PRPRDC/2012-2013/SACETP/539

Mohan Kumar MJ
Sr. Engineer - BD
19th June 2012

To,

Mr. V. C. Eugin Martin Raj
Lecturer/EEE Department
St. Anne's College of Engineering and Technology
Anguchettypalayam, Siruvathur Post, Panruti Taluk,
Cuddalore - 607110

Sub: Letter for accepting to provide 15% discount of the quoted price for supply of 30 Users
MiPower - Power System Simulation Software to as per Anna University Syllabus

Reference: Purchase Order: SACET/EEE/02/11-12 dated 29-03-2012

Dear Sir,

We thank you for placing the MiPower Software order on us. With reference to the above subject we hereby agree to provide 15% discount on the quoted price for supply of 30 users MiPower Software LAN Version Hardware lock as per Anna University Syllabus.

The current price after the discount will be Rs: 4,13,993/- (Rupees Four Lakhs Thirteen Thousand Nine Hundred and Ninety Three Only) inclusive of 5% CST Tax.

We request you to kindly accept our discounted price and release the payment at the earliest.

Thanking you and assuring you of our best services at all times.

Yours sincerely

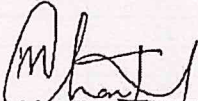
Mohan Kumar MJ
Mobile: 09620840340



 POWER RESEARCH & DEVELOPMENT CONSULTANTS PRIVATE LIMITED, # 5 11th Cross, 2nd Stage, West of Chord Road, Bangalore - 500 086 Tel : +91-80-23192159, 23192168, 23192209 Fax: 23192210 E-mail : prdc@vsnl.com KST : 71628873 CST : 71678876)dtd 6-5-95 Employee's Provident Fund Code No.KN/BN/19905 SERVICE TAX Regn. No.: AABCP3291JST001 IEC N.: 0703013891 PERMANENT A/c No. : AABCP3291J TIN No: 29340028246 Dtd:01.04.2003	TAX INVOICE
	INVOICE NO: 18428 DATE: 31.03.2012

The Principal
St. Anne's College of Engineering and Technology
 Anguchettypalayam,
 Siruvathur Post, Panruti Taluk,
 Cuddalore District, - 607110
 Tamil Nadu

P.O. NUMBER	P.O.DATE	D.C. NO.	D.C.DATE	NATURE OF JOB
SACET/EEE/02/11-12	29.03.2012	-		SOFTWARE SUPPLY

SL.NO	DESCRIPTION	QTY	UNIT PRICE	AMOUNT IN INR	
1	SOFTWARE SUPPLY			463,858.00	
NARRATION :				SUBTOTAL	463,858.00
1. Supply of MiPower Simulation Software				CST @ 5%	23193.00
2. 80% order value (Rs 4,63,858/-) against delivery,				TOTAL	487,051.00
3. 20% of the order value (Rs 4,63,858/-) after installation and Training					
4. CST @ 5% Extra.					
				less 15%.	413993.00

In Words: (Rupees Four Lakh Eighty Seven Thousand Fifty One Only)

TERMS :

1. Make all DDs payable to : Power Research & Development Consultants Private Limited, Bangalore.
2. 24% Interest is applicable if the bill is not cleared within 15 days.

Our Bank Account Details

IFSC CODE:

Beneficiary's Bank:

Beneficiary's Account Number:

Beneficiary's Account Name

Beneficiary's Address

CNRB0000886

Canara Bank, Mahalakshmi Layout branch, Bangalore - 86

0886261010300

Power Research & Development Consultants Pvt. Ltd.

#5, 11th Cross, West of Chord Road, II Stage,

Bangalore - 560086, Karnataka, INDIA

Sachin
Prepared by

Checked by

for POWER RESEARCH & DEVELOPMENT
CONSULTANTS PRIVATE LTD.



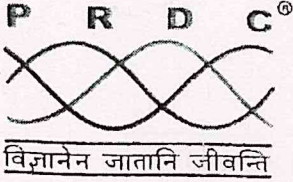

**Power Research & Development
Consultants Private Limited**

#5, 11th Cross, 2nd Stage, West of Chord Road, Bangalore 560086, INDIA
Phone: +91 - 80 - 4245-5555 / 2319-2209
Fax: +91 - 80 - 4245-5556 / 2319-2210
E-mail: prdc@vsnl.com Website: www.prdcinfotech.com

Ref: PRDC/2011-2012/SACET/1760

H. R. Venkatesh
Head - Marketing

March 31, 2012

To,
St. Anne's College of Engineering and Technology
Anguchettyalayam, Siruvathur Post, Panruti Taluk,
Cuddalore District, - 607110
Tamil Nadu.
Phone: 04142 -242661, 243661, 241661, 242661
Fax: 04142-242661

Kind Attn.: HOD Of Electrical & Electronics Engineering

Dear Sir,

Sub:- Supply of MiPower™ Software Anna University Package with 100 Nodes

Ref: PO No. SACET/EEE/02/11-12 dated: 29-Mar-2012

With reference to the above, we thank you for placing the order on us. Please find herewith enclosed MiPower™ Software package version - 6 in CD media, Hardware lock- USB Network lock for Thirty users licence, User manuals, Installation Manual and Delivery Challan. Kindly acknowledge the receipt. Kindly return the Delivery Challan super scribed as 'PRDC Copy' duly signed with seal and date.

Also please find herewith enclosed the Invoice No.: 18428 dated: 30.03.2012 for an amount of Rs. 4,87,051/- (Rupees Four Laks Eighty Seven Thousand Fifty One Only).

Kindly arrange for the payment at the earliest.

Please feel free to contact the undersigned if you have any questions / clarification.

Thanking you again and assuring you of our prompt attention always,

Yours Faithfully

(Signature)
for (H. R. Venkatesh)



Encl.:

1. CD (No. 6356-30) - 1 No.
2. USB Network Lock No. 3974 - 1410 - 1 No.
3. MiPower™ User Manuals - 1 set
4. Delivery Challan in Duplicate
5. Authenticity Certificate
6. Invoice in Duplicate

28600
5000
750
34350
1550
35900

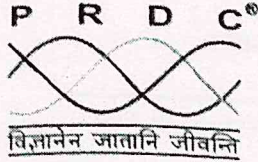

**Power Research & Development
Consultants Private Limited**

#5, 11th Cross, 2nd Stage, West of Chord Road, Bangalore -560086, INDIA
 Phone: +91 - 80 - 4245-5555 / 2319-2209
 Fax: +91 - 80 - 4245-5556 / 2319-2210
 E-mail: prdc@vsnl.com Website: www.prdcinfotech.com

**Quotation for supply of – MiPower™
For Windows- 98/NT/2000/XP/2003/VISTA**

MiPower™ Supporting 100 Nodes/Buses as Per Anna University Syllabus

Sl. No	Modules / Particulars	License Quantity	Price in INR
1	MiPower FULLY FUNCTIONAL Graphical User Interfaces Power System Network Editor Database Manager Batch Mode Interface Multi Graph Plotter AutoCAD Interface Free Programmable Blocks Automatic Single Line Diagram Generator Report Generator Power LFA - Load Flow Analysis Fast-De Coupled option Newton – Raphson option Gauss – Seidel method option Frequency dependent load flow Contingency ranking Economic Dispatch Open Access Feasibility Reliability Indices Computation Present Worth Computation Real & Reactive power optimization Custom Reports Power SCS - Short-Circuit Study Multi-case / Multi islanding / Multi generation version Motor contribution Earthing and Zigzag transformer Reactor Sizing Loop & Radial systems Travelling shunt fault Custom Reports Power TRS - Transient Stability Study Unlimited disturbances Motor Starting analysis User defined Control system (AVR, SVC, HVDC, ULTC) IEEE PSS Text + Graphical outputs Long term demand forecast Line and Cable parameter calculation Electro Magnetic Transient Program MiPower Tools	10 Users	Rs:2,77,518/-
		20 Users	Rs:3,70,688/-
		30 Users	Rs:4,63,858/-

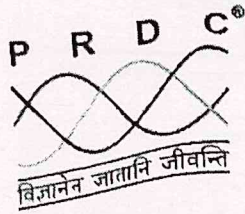

**Power Research & Development
Consultants Private Limited**

#5, 11th Cross, 2nd Stage, West of Chord Road, Bangalore - 560086, INDIA
 Phone: +91 - 80 - 4245-5555 / 2319-2209
 Fax: +91 - 80 - 4245-5558 / 2319-2210
 E-mail: prdc@vsnl.com Website: www.prdcinfotech.com

MiPower™ Supporting Unlimited Nodes/Buses as Per Anna University Syllabus

Sl. No	Modules / Particulars	License Quantity	Price in INR
1	MiPower FULLY FUNCTIONAL Graphical User Interfaces Power System Network Editor Database Manager Batch Mode Interface Multi Graph Plotter AutoCAD Interface Free Programmable Blocks Automatic Single Line Diagram Generator Report Generator Power LFA - Load Flow Analysis Fast-De Coupled option Newton – Raphson option Gauss – Seidel method option Frequency dependent load flow Contingency ranking Economic Dispatch Open Access Feasibility Reliability Indices Computation Present Worth Computation Real & Reactive power optimization Custom Reports Power SCS - Short-Circuit Study Multi-case / Multi islanding / Multi generation version Motor contribution Earthing and Zigzag transformer Reactor Sizing Loop & Radial systems Travelling shunt fault Custom Reports Power TRS - Transient Stability Study Unlimited disturbances Motor Starting analysis User defined Control system (AVR, SVC, HVDC, ULTC) IEEE PSS Text + Graphical outputs Long term demand forecast Line and Cable parameter calculation Sub-Synchronous Resonance Voltage Instability Analysis MiPower Tools	10 Users	Rs:4,50,548/-
		20 Users	Rs:7,06,748/-
		30 Users	Rs:9,72,948/-

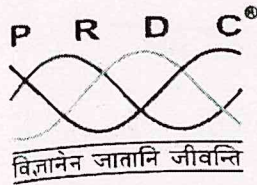

**Power Research & Development
Consultants Private Limited**

#5, 11th Cross, 2nd Stage, West of Chord Road, Bangalore -560086, INDIA
 Phone: +91 - 80 - 4245-5555 / 2319-2209
 Fax: +91 - 80 - 4245-5556 / 2319-2210
 E-mail: prdc@vsnl.com Website: www.prdcinfotech.com

MiPower™ Supporting Unlimited Nodes/Buses Industrial Version Full Package

SI No	MiPower™ Configuration – Industrial Version	No. Of User License	List Price INR
01	Graphical User Interfaces ✓ Power System Network Editor ✓ Database Manager ✓ Batch Mode Interface ✓ MultiGraph Plotter ✓ AutoCAD Interface ✓ Free Programmable Blocks ✓ Automatic Single Line Diagram Generator ✓ Report Generator power LFA - Load Flow Analysis ✓ Fast-DeCoupled option ✓ Newton – Raphson option ✓ Gauss – Seidel method option ✓ Frequency dependent load flow ✓ Contingency ranking ✓ Present Worth Computation ✓ Real & Reactive power optimization ✓ Custom Reports Power SCS - Short-Circuit Study ✓ Multi-case / Multi islanding / Multi generation version ✓ Motor contribution ✓ Earthing and Zigzag transformer ✓ Reactor Sizing ✓ Loop & Radial systems ✓ Traveling shunt fault ✓ Custom Reports Power TRS - Transient Stability Study ✓ Unlimited disturbances ✓ Motor Starting analysis ✓ User defined Control system (AVR, SVC, ✓ HVDC, ULTC) ✓ IEEE PSS ✓ Text + Graphical outputs Power RCD - Relay Co-ordination ✓ Automatic / Interactive / Manual Primary-back-up relay pairs generation ✓ Phase and Earth relay co-ordination ✓ Optimum setting for Motor relays ✓ Extensive database of relays and fuse ✓ Pick, drag and drop relay curves ✓ Fault simulation and relay trip sequence ✓ Export to AutoCAD ✓ Optional inclusion of motor contribution during fault simulation Economic Dispatch Harmonic analysis Long term demand forecast Line and Cable parameter calculation Sub-Synchronous Resonance Voltage Instability Analysis Dynamic stability study with Network Reduction Electro Magnetic Transient Stability (EMTP) Open Access Feasibility Reliability Indices Computation Ground Mat Design Three-phase Load Flow	05 Network Users	Rs. 5,06,994/-
	10 Network Users	Rs. 6,53,736/-	
	15 Network Users	Rs. 8,00,479/-	
	20 Network Users	Rs. 9,47,222/-	
02	Brand New Universal Lock Secure	FREE	FREE

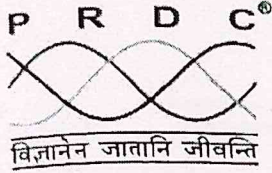

**Power Research & Development
Consultants Private Limited**

#5, 11th Cross, 2nd Stage, West of Chord Road, Bangalore -560086, INDIA
 Phone: +91 - 80 - 4245-5555 / 2319-2209
 Fax: +91 - 80 - 4245-5556 / 2319-2210
 E-mail: prdc@vsnl.com Website: www.prdcinfotech.com

Hardware (Computer System) Requirements	
Minimum PC Configuration	Recommended PC Configuration
Pentium II 400 MHz, 64 MB RAM, 1 GB HDD, 1 parallel port, CD-ROM drive, 14"Color monitor supporting 800X600 pixels, Standard Key Board & Mouse, Windows 98 Operating System	Intel Core-2 Duo 3.0 GHz, 1 GB RAM, 160 GB HDD, 1 USB port, 52X Combo DVD Drive, 17" Color monitor supporting 800X600, Standard Key Board and Mouse, Windows 2000/XP/Vista
<p>All the PCs must be connected with Local Area Network (LAN) Any configuration between above-mentioned minimum and recommended configuration will suffice.</p>	

- Following are bundled **FREE of cost**
- Power System Network (One Line) Editor
 - Database Manager & MultiGraph Plotter
 - Hardware Lock – Network Edition
 - Automatic Single Line Diagram Generator
 - AutoCAD Interface
 - How To Solve MiPower™ Manuals
 - User Manuals
 - License Certificate



ST. ANNE'S COLLEGE OF ENGINEERING AND TECHNOLOGY
(Approved by AICTE, New Delhi. Affiliated to Anna University, Chennai)
ANGUCHETTYPALAYAM, PANRUTI – 607 106.

2. PV EMULATOR SOFTWARE

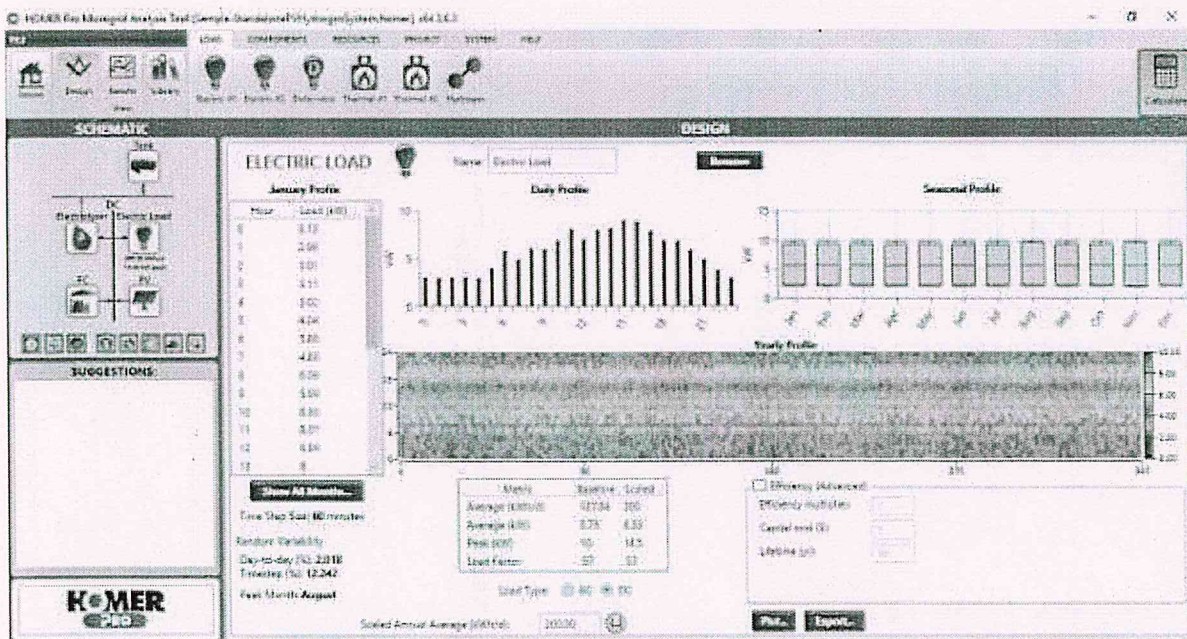
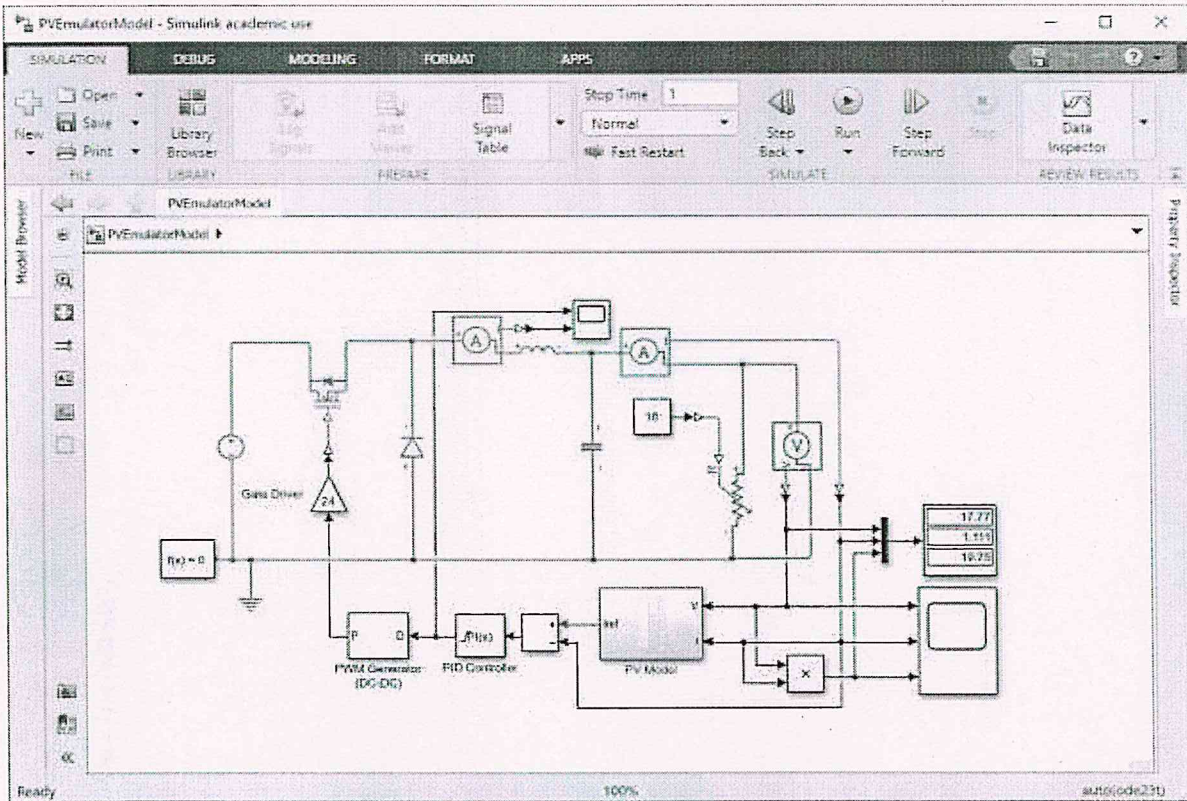

COLLEGE OF ENGINEERING AND TECHNOLOGY

(A Unit of the Sisters of St. Anne, Trichy)
(Approved by AICTE, New Delhi. Affiliated to Anna University, Chennai)

(An ISO 9001 : 2015 Certified Institution)
Anguchettyalaya, Panruti - Taluk, Cuddalore District - 607106
Phone: 04142-242661, 243661. Email: stannescet@gmail.com

Lr. From AICTE File No. 07/08/TN/E&T/2009/20

Date: 10.03.2020

Purchase orders No: SACET / EEE/ 02/ 2020-2021

To

The Manager,
Jayam Electronics,
12/21, 1st Main Road,
Venkateswara Nagar;
Velachery, Chennai-600 042.

Sir,

Sub: Purchase of the equipments for EEE Lab-Reg.

Ref: Your quotation No. JE/QTN-EC/233/2020-21 dated on 02. 03.2020.

I would like to place the order for the following items for EE871- Renewable Energy Lab. Kindly supply the same at the earliest as possible.

S.No.	Description of Equipment	Quantity required	Amount Rs.
1	PV Panel with Mounting Structure and Battery Storage System with charge and discharge control	1No.	1,80,000.00
2	PV Emulator with Simulation software	1No.	65,000.00
3	Micro Wind Energy Generator Module with Simulation software	1No.	1,20,000.00
4	Digital Multi meter	10Nos.	6,500.00
5	Potentiometer	5Nos.	120.00
6	Step-down transformer	5Nos.	1,000.00
7	CRO/DSO	9Nos.	1,80,000.00
Total Cost			5,52,620.00
GST 18%			99,471.00
Total cost with GST 18%			652091.00

Terms & Conditions

1. GST :18% included
2. Packing and forwarding :Nil
3. Payment :100% against delivery
4. Delivery time :15-20 days
5. Dispatch :By Hand delivery
6. Warranty :12 months

R. Murugadas
10.3.20

Thanking you

COLLEGE OF ENGINEERING AND TECHNOLOGY

(A Unit of the Sisters of St. Anne, Trichy)
(Approved by AICTE, New Delhi, Affiliated to Anna University, Chennai)

(An ISO 9001 : 2015 Certified Institution)
Anguchettypalayam, Panruti - Taluk, Cuddalore District - 607106

Phone: 04142-242661, 243661. Email: stannescet@gmail.com

Lr. From AICTE File No. 07/08/TN/E&T/2009/20

Purchase orders No : SACET /IEEE/01/19-20

Date: 04-02-2020

To:

J.K.SYSTEMS,
19/6,1 Floor,
M.K.P. Hospital Road,
Palayamkottai,
Tirunelveli - 2.

Sir,

Sub: Purchasing of I3Systems - reg.

I would like to place the order for the following Lenovo, I3 Systems. Supply the same at the earliest as possible.

SL NO	DESCRIPTION	Unit Cost	QTY	TOTAL
1.	Lenovo V530 Desktop Intel Gen9 B360 i3 9100 Processor 3.6GHz Speed 8GB DDR4 Memory 1TB Hard Disk DOS ,19.5 inch Monitor, Keyboard & Mouse	Rs. 34,750/-	15 Nos	Rs.5,21,250/-
Total Cost				Rs. 5,21,250/-

Terms & Conditions

1. Prices : Are net including VAT.
2. Payment Terms : 100% Advance D.D
3. Delivery : 10 Days from the date of P.O.

Thanking You.

Yours Sincerely

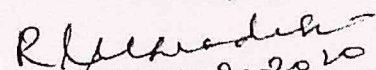
Dr. R. AROKADASS, M.E., Ph.D.,
Principal,

St. Anne's College of Engineering & Technology,
ANGUCHETTYPALAYAM,
Siruvathur-(Post), Panruti-Taluk,
Cuddalore District - 607106

INVOICE

JAYAM ELECTRONICS

(Manufacturers and Dealer of Electrical & Electronics Instruments)

GSTIN 33AAFFJ2095K129
PAN AAFFJ2095K

13/43, Annamalai Nagar, 3rd Street, Mellupalayam,
West Mambalam, CHENNAI - 600 033.

Phone : 044 - 43521501, 8784601574 (Office)
Mobile : 98772 52848, 94440 01354, 94444 97474, 98772 82934
website : www.jayamelectronics.com, www.jayamelectronics.in
e-mail : jayamelectronics@gmail.com
jayamelectronics@yahoo.co.uk

To,

The Principal,
St. Anne's College of Engineering & Technology,
Anguchettipalayam, Siruvathur (Post),
Panrutti Taluk - 607 110
Cuddalore DT

Invoice No : JE/INV/GST-016/2020-21
Date : 10.10.2020
Customer Order : SACET/BBE/02/20-21
Reference No. : Dated: 10.03.2020
Date :
Delivery Note No. : JE/DC/GST-004/2020-21
Date : 10.10.2020
Despatched thro : By Hand delivery

S. No.	Description	Rate		Qty	Amount	
		Rs.	P.		Rs.	P.
1.	PV Panel with mounting structure and battery storage system with charge and discharge control Trainer kit HSN NO:9023	1,80,000-00		1 No.	1,80,000-00	
2.	PV Emulator trainer with simulation software HSN NO:9023	65,000-00		1 No.	65,000-00	
3.	Micro Wind energy Generator with simulation software HSN NO:9023	1,20,000-00		1 No.	1,20,000-00	
4.	Digital Multi meter HSN NO:9030	650-00		10 Nos.	6,500-00	
Total						3,71,500-00
Add: CGST @ 9%						33,435-00
Add: SGST @ 9%						33,435-00
Grand Total						4,38,370-00
(Rupees Four lakhs thirty eight thousand three hundred and seventy only)						

Cheque / D.D. Should be drawn on the name of "JAYAM ELECTRONICS"

Receiver's Signature :

Date :

Name :

Contact No. :

e-mail ID :

Seal :

For **JAYAM ELECTRONICS**



Authorized Signature

Cheque / D.D. Should be drawn on the name of "JAYAM ELECTRONICS"

BANK DETAILS:

Account Holder Name : **JAYAM ELECTRONICS**
Account No. : 30730185011
IFS Code : SBIN0011720
MICR Number : 600002165
PAN : AAFFJ2095K
Our Bank : State Bank of India
Branch : (11720) West Saidapet,
61/1, West Jones Road,
CHENNAI - 600 015.

Goods supplied by :
Bearer name :
Signature :
Contact No. :
Completed / Pending / Return :
Remark :

Dear Sir,
Please write your feedback.
Can we upload it to our web site "www.jayamelectronics.com" on the testimonials page?
Thank you

DELIVERY CHALLAN

JAYAM ELECTRONICS
 (Manufacturers and Dealer of Electrical & Electronics Instruments)

13/43, Annamalai Nagar, 3rd Street, Mettupalayam,
 West Mambalam, CHENNAI 600 033
 Phone . 044 43521501; 8754501574 (Office)
 Mobile . 96772 52848; 94440 01354, 94444 97474; 96772 82034
 website . www.jayamelectronics.com; www.jayamelectronics.in
 e-mail . jayamelectronicsje@gmail.com
 jayamelectronics@yahoo.co.uk

GSTIN : 33AAFFJ2095K1Z9
 PAN : AAFFJ2095K

Goods Consigned To.,
 The Principal,
St. Anne's College of Engineering & Technology
 Anguchettipalayam, Siruvathur (Post),
 Panrutti Taluk - 607 110
 Cuddalore DT

DC No. : JE/DC/GST-004/2020-21
 Date : 10.10.2020
 Customer Order No. : SACET/EEE/02/20-21
 Date : 10.03.2020
 Mode of Despatch : By Hand Delivery

S. No.	Description	Qty	Remarks
1.	PV Panel with mounting structure and battery storage system with charge and discharge control a. Solar pv module trainer - 1 No. b. Solar panel 12V,165w - 1 No. c. 1000W halogen light with stand -1 NO. d. Thermo couple - 1 No. e. Lux meter -1 No. f. 12 V DC Lamp - 4 Nos. g. 40W lamp -4 Nos. h. Solar Battery 40Ah,12V - 1 No.	1 No.	
2.	PV Emulator with simulation software	1 No.	
3.	Micro Wind energy Generator a. 100W PMSG generator with stand -1 No. b. Wind energy generator trainer - 1 No. c. Anemometer - 1 No. d. Solar Battery 40Ah, 12V - 1 No. e. Solar panel 165W ,12V - 1 No. f. 12V DC Lamp - 4 Nos. g. 40W Lamp - 4 Nos. h. 1 HP Air blower - 1 No.	1 No.	
4.	Digital Multi meter	10 Nos.	

Received the above said Materials in good condition.

Receiver's Signature :
 Date :
 Name :
 Contact No. :
 e-mail ID :
 Seal :

For **JAYAM ELECTRONICS**

CHENNAI - 600 033
 Authorized Signature

Cheque / D.D. Should be drawn on the name of "JAYAM ELECTRONICS"

BANK DETAILS:

Account Holder Name : JAYAM ELECTRONICS
Account No. : 30730185011
IFS Code : SBIN0011720
MICR Number : 600002165
PAN : AAFFJ2095K
Our Bank : State Bank of India
Branch : (11720) West Saidapet,
61/1, West Jones Road,
CHENNAI 600 015

Goods supplied by :
Bearer name :
Signature :
Contact No. :
Completed / Pending / Return :
Remark :

Dear Sir,
Please write your feedback.
Can we upload it to our web site "www.jayamelectronics.com" on the testimonial page?
Thank you.

DELIVERY CHALLAN

JAYAM ELECTRONICS

(Manufacturers and Dealer of Electrical & Electronics Instruments)

GSTIN : 33AAFFJ2095K1Z9

PAN : AAFFJ2095K

13/43, Annamalai Nagar, 3rd Street, Mettupalayam,
West Mambalam, CHENNAI - 600 033.

Phone : 044 - 43521501; 8754501574 (Office)

Mobile : 96772 52848; 94440 01354; 94444 97474; 96772 82034

website : www.jayamelectronics.com; www.jayamelectronics.in

e-mail : jayamelectronicsje@gmail.com

: jayamelectronics@yahoo.co.uk

Goods Consigned To,

The Principal,
St. Anne's College of Engineering & Technology
Anguchettipalayam, Siruvathur (Post),
Panrutti Taluk - 607 110
Cuddalore DT

DC No. : JE/DC/GST-004/2020-21
10.10.2020

Date : -

Customer Order No. : SACET/EEE/02/20-21
10.03.2020

Date : -

Mode of Despatch : By Hand Delivery

S. No.	Description	Qty	Remarks
1.	PV Panel with mounting structure and battery storage system with charge and discharge control a. Solar pv module trainer - 1 No. b. Solar panel 12V,165w - 1 No. c. 1000W halogen light with stand -1 NO. d. Thermo couple - 1 No. e. Lux meter -1 No. f. 12 V DC Lamp - 4 Nos. g. 40W lamp -4 Nos. h. Solar Battery 40Ah,12V - 1 No.	1 No.	
2.	PV Emulator with simulation software	1 No.	
3.	Micro Wind energy Generator a. 100W PMSG generator with stand -1 No. b. Wind energy generator trainer - 1 No. c. Anemometer - 1 No. d. Solar Battery 40Ah, 12V - 1 No. e. Solar panel 165W ,12V - 1 No. f. 12V DC Lamp - 4 Nos. g. 40W Lamp - 4 Nos. h. 1 HP Air blower - 1 No.	1 No.	
4.	Digital Multi meter	10 Nos.	

Received the above said Materials in good condition.

Receiver's Signature :

Date :

Name :

Contact No. :

e-mail ID :

Seal :

For **JAYAM ELECTRONICS**

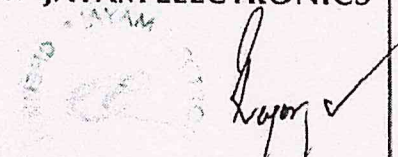

Authorized Signature

Cheque / D.D. Should be drawn on the name of "JAYAM ELECTRONICS"

BANK DETAILS:

Account Holder Name : **JAYAM ELECTRONICS**
Account No. : 30730185011
IFS Code : SBIN0011720
MICR Number : 600002165
PAN : AAFFJ2095K
Our Bank : State Bank of India
Branch : (11720) West Saidapet,
61/1, West Jones Road,
CHENNAI - 600 015.

Goods supplied by :
Bearer name :
Signature :
Contact No. :
Completed / Pending / Return :
Remark :

Dear Sir,
Please write your feedback.
Can we upload it to our web site "www.jayamelectronics.com" on the testimonials page?
Thank you



ST. ANNE'S COLLEGE OF ENGINEERING AND TECHNOLOGY

(A Unit of the Sisters of St. Anne, Trichirapalli.)

Anguchettypalayam, Siruvathur Post, Panruti Taluk - 607 110. Cuddalore District

Phone : 04142 - 242661, 243661

Email id : stannescet@gmail.com

Lr. From AICTE File No. 07/08/TN/E&T/2009/20

PRINCIPAL

Purchase order No: SACET /ECE /02/11-12

Date: 23.03.2011

To,

The Manager,
CorEL technologies (I) Pvt., Ltd.,
21, 7th Main I Block,
Koramangala,
Bangalore-560034.

Sir,

Kindly refer your Quotation No# CG/TN/MW/2010-11/KM/238 for MATLAB software and please register this order to the condition overleaf. Kindly check the correction with the previous purchase order no SACET /ECE /01/11-12 dated 17.03.2011.

TERMS OF PAYMENT : 100% ADVANCE ALONG WITH PURCHASE ORDER.

DELIVERY : WITHIN 6-8 WEEKS FROM THE DATE OF RECEIPT OF OUR CLEAR AND ACCEPTABLE PURCHASE ORDER.

S.NO	ITEM	QUOTE PRICE	UNITS	EXTENDED PRICE
1	MATLAB(ALL)	16100.00	15	2,41,500.00
2	SIMULINK(ALL)	8050.00	15	1,20,750.00
3	Control system tool box	8855.00	05	44,275.00
4	Sim Power	16100.00	15	2,41,500.00
5	Signal processing Tool Box	8855.00	05	44,275.00
6	Sim Hydraulics	8855.00	05	44,275.00
7	Sim Neumatics	8855.00	05	44,275.00
8	Sim Scape	8855.00	05	44,275.00
TOTAL				8,25,125.00
Sales Tax 5%				41,256.25
TOTAL				8,66,381.25

Thanking you.

Yours sincerely,

J. S. S. S.
Principal (23/3/11)
St. Anne's College of Engineering & Tech
ANGUCHETTYPALAYAM,
Siruvathur-Post, Panrut
Cuddalore-Dist, 607 11

23.846/-

Advance Amount should be

collected



ST. ANNE'S COLLEGE OF ENGINEERING AND TECHNOLOGY

(A Unit of the Sisters of St. Anne, Trichirapalli.)

Anguchettypalayam, Siruvathur Post, Panruti Taluk - 607 110. Cuddalore District.

Phone : 04142 - 242661, 243661

Email id : stannescet@gmail.com

Lr. From AICTE File No. 07/08/TN/E&T/2009/20

PRINCIPAL

Purchase order No: SACET /ECE /01/11-12

Date: 17.03.2011

To,

The Manager,
CorEL technologies (I) Pvt., Ltd.,
21, 7th Main I Block,
Koramangala,
Bangalore-560034.

Sir,

Kindly refer your Quotation No# CG/TN/MW/2010-11/KM/238 for MATLAB software and please register this order to the condition overleaf.

TERMS OF PAYMENT : 100% ADVANCE ALONG WITH PURCHASE ORDER.
DELIVERY : WITHIN 6-8 WEEKS FROM THE DATE OF RECEIPT OF OUR CLEAR AND ACCEPTABLE PURCHASE ORDER.

S.NO	ITEM	QUOTE PRICE	UNITS	EXTENDED PRICE
1	MATLAB(ALL)	16100.00	15	2,41,500.00
2	SIMULINK(ALL)	8050.00	15	1,20,750.00
3	Control system tool box	8855.00	05	44,275.00
4	Sim Power	16100.00	15	2,41,500.00
5	Signal processing Tool Box	8855.00	05	44,275.00
6	Sim Hydraulics	6440 10350.00	05 15	51,750.00
7	Sim Neumatics	6440 10350.00	05 15	51,750.00
8	Sim Scape	6440 10350.00	05 15	51,750.00
TOTAL				8,47,550.00
Sales Tax 5%				42,377.50
TOTAL				8,89,927.50

₹ 1,41,592.50

Thanking you.

Yours sincerely,

ENCL:- DD FOR AMOUNT
RS 8,89,927.00

DD.NO :- 837087

DATED :- 18-3-2011

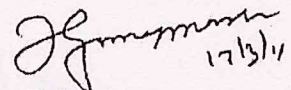

Principal

St Anne's College of Engineering & Technology
ANGUCHETTYPALAYAM,
Siruvathur Post, Panruti-Tk,
Cuddalore-Dist, 607 110

TAX INVOICE

Bill to ST ANNEs COLLEGE OF ENGINEERING AND TECHNOLOGY Anguchettyalayam, Siruvathur Post, Panruti Taluk-607110	Invoice No. DST/2010-11/394	Dated 30-Mar-2011
	Purchase Order No. SACET/ECE/02/11-12	Purchase Order Date 23-Mar-2011
	Delivery Note NA	Mode/Terms of Payment 100% Advance
Shipped to ST ANNEs COLLEGE OF ENGINEERING AND TECHNOLOGY Anguchettyalayam, Siruvathur Post, Panruti Taluk-607110	Shipped Date	Buyers TIN NA
	Price Basis Purchase Order	Remarks

#	Particulars	Quantity	Rate	Amount
1	MATLAB(MALL)	15	16,100.00	241,500.00
2	SIMULINK (ALL)	15	8,050.00	120,750.00
3	Control system tool box	05	8,855.00	44,275.00
4	Sim Power	15	16,100.00	241,500.00
5	Signal Processing Tool Box	05	8,855.00	44,275.00
6	Sim Hydraulics	05	8,855.00	44,275.00
7	Sim Neumatics	05	8,855.00	44,275.00
8	Sim Scape	05	8,855.00	44,275.00
SUB TOTAL				825,125.00
CST @ 5%				41,256.00

Total Amount INR 866,381.00

Amount in words

INR Eight Lakh Sixty Six Thousand Three Hundred Eighty One Only

K.S.T No. : 90207907
 C.S.T No. : 90257900
 VAT TIN : 29600080386
 Service Tax : AABCC1915EST001
 PAN No. : AABCC1915E

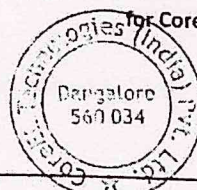

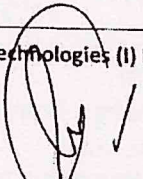
For CoreEL Technologies (I) Pvt. Ltd.

 Authorised Signatory



ST. ANNE'S COLLEGE OF ENGINEERING AND TECHNOLOGY

(A Unit of the Sisters of St. Anne, Trichirapalli.)

Anguchettypalayam, Siruvathur Post, Panruti Taluk - 607 110. Cuddalore District.

Phone : 04142 - 242661, 243661

Email id : stannescet@gmail.com

Lr. From AICTE File No. 07/08/TN/E&T/2009/20

INCIPAL

ULTIMATE END-USER / END-USE STATEMENT

Date	17.03.2011
Registered END-USER'S Name	Dr.T. Ganapathy
Name of Company or University	St.Anne's College of Engineering and Technology
Department	Electrical and Electronics Engineering
Address	Anguchettypalayam, Panruti, Cuddalore Dist.,
City/State/Postal Code	Panruti-607110. Tamilnadu
Country	India
Phone (include country/city code)	04142-242661
Fax (include country/city code)	04142-242661
Email Address	Stannescet@gmail.com
Web Address	www.stannescet.ac.in
Log or New MathWorks License #	-

For **COMPANIES**, it is important that you describe in detail the **NATURE OF YOUR BUSINESS**, **DESCRIBE THE APPLICATION OF THE SOFTWARE**, as well as **THE TYPE OF PROJECT(S)** for which software will be used. For **UNIVERSITIES**, your statement must include the **DEPARTMENT**, **COURSE NAME(S)** and **class syllabus** or **DESCRIPTION OF THE RESEARCH** for which the software is being purchased. (If requested details are not provided, we will request additional information and your order will be placed on hold).

For Academic Purpose. For teaching mechanical

Will you be using The MathWorks' products connected to the development, production or use of -
(Check yes or no, or if unsure, please explain further by describing in detail the specific project. Please type or print)

2a) Chemical or Biological Weapons No Yes

2b) Missile Technology (ie, rocket systems, UAV, SLV, Ballistic Missiles) No Yes

If unsure, please provide the characteristics (i.e. range capabilities) and a description of the type of load to be carried

2c) Nuclear Activities, including devices, facility and fuel cycle activities No Yes

2d) Civil or Military Satellite Projects No Yes

2e) Maritime Nuclear Propulsion Projects, including related facilities and equipment No Yes

STATEMENT OF ULTIMATE CONSIGNEE AND PURCHASER: We certify that all facts contained in this statement are true and correct to the best of our knowledge and we do not know of any additional facts which are inconsistent with the above statement. We shall promptly send a supplemental statement to The MathWorks, disclosing any change of facts or intentions set forth in this statement which occurs after the statement has been prepared and forwarded. We will not re-export, resell, or otherwise dispose of any items related to this statement contrary to the US Export Administration Regulations except as specifically authorized by the U.S. Export Administration Regulations (15 CFR parts 730-774), or by prior written approval of the Bureau of Industry and Security and/or The MathWorks.

Dr.T. Ganapathy
Name of person certifying this information (Please type or print)

Professor
Title (Please type or print)

Signature of person certifying this information
Principal

17-03-2011
Date (Month/Day/Year)

St. Anne's College of Engineering & Technology, (Request for: EUS Form Rev: June 27, 2007 - RM)
ANGUCHETTYPALAYAM,
Siruvathur Post, Panruti-Tk,
Cuddalore-Dist, 607 110

ST. ANNE'S COLLEGE OF ENGINEERING AND TECHNOLOGY

STOCK LEDGER OF NON- CONSUMABLE STORES

Name of Article MATLAB SOFTWARE - corecal tech

Date	Name of Supplier / Supply Order No / To Whom issued	Bill No. & Date	Cost of the Item	Qty. Received	Indent No.	Issued	Balance	Remarks
01/06/2011	<u>MATLAB SOFTWARE</u>	0394						
		2ds/2011	16,100/-	15				
			2,41,500					
<p>The above items are checked and verified from page no 01 to 02.</p>								
<p><i>M. V. Srinivas</i> LAB INCHARGE</p>					<p>verified by <i>P. Murugan</i> AP/Member Staff</p>			
<p><i>S. K. Srinivas</i> H. O. D 6/5/13.</p>					<p><i>[Signature]</i> PRINCIPAL</p>			

Audrino

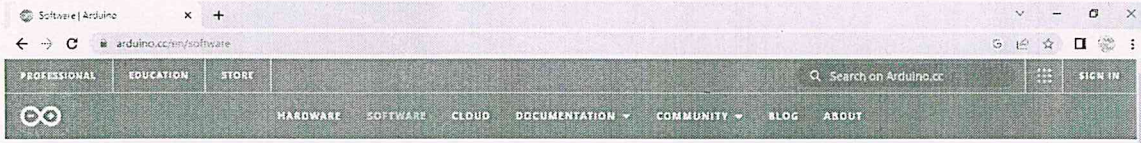

Downloads

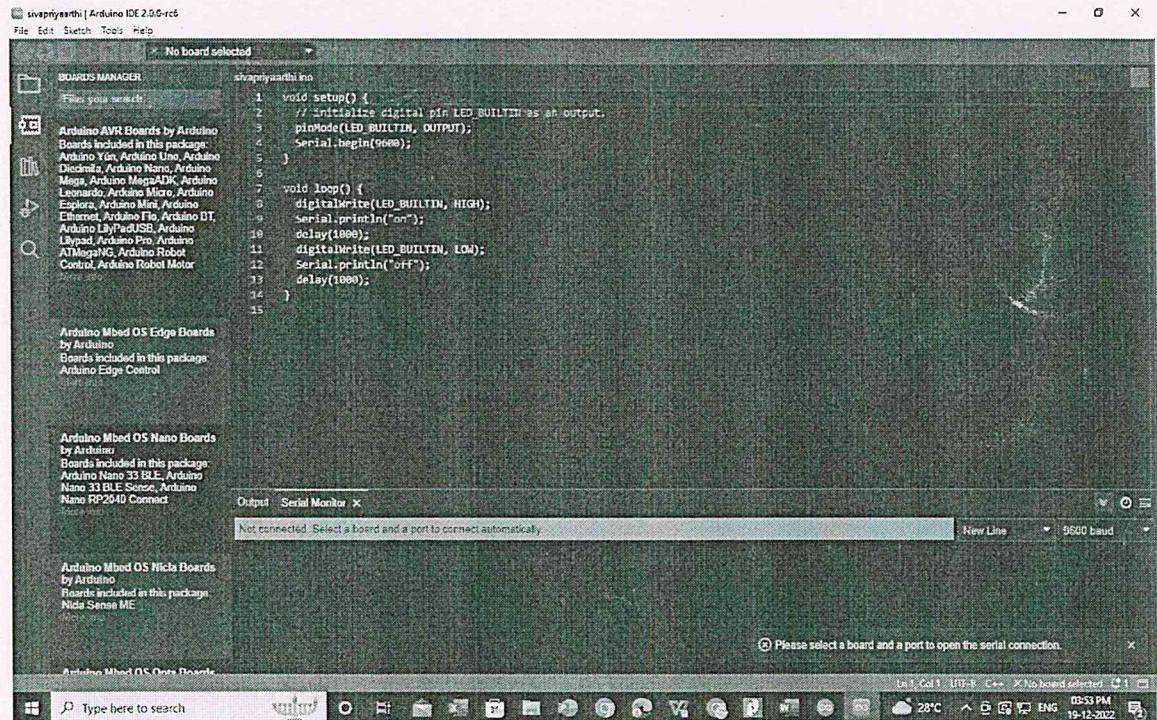
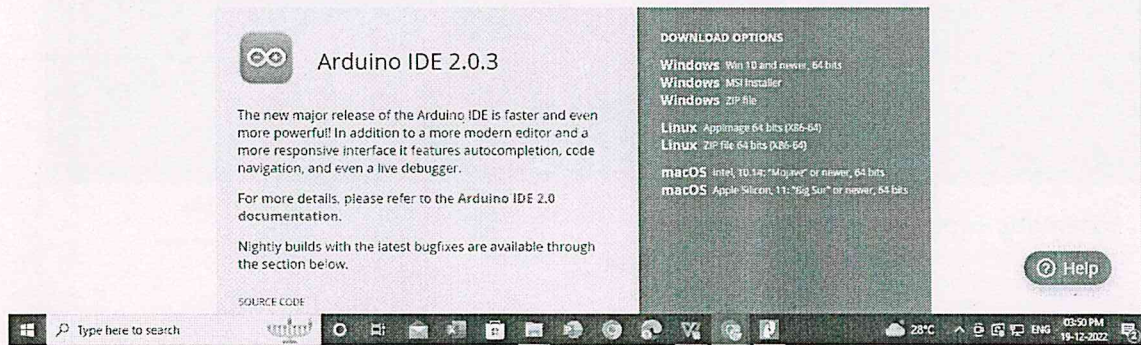

Ki CAD

The KiCad 2022 Fund Drive is here!
Donate now to be matched by KiCad Services

\$29,192 DONATED \$100,000 TOTAL

KiCad CORPORATION

BLOG DISCOVER COMMUNITY HELP CONTRIBUTE SPONSORS LIBRARIES DOWNLOAD ABOUT Donate

KiCad EDA

A Cross Platform and Open Source Electronics Design Automation Suite

Documentation Download See what's new

Schematic Capture

KiCad's Schematic Editor supports everything from the most basic schematic to a complex hierarchical design with hundreds of sheets. Create your own custom symbols or use some of the thousands found in the official KiCad library. Verify your design

Latest Blog Posts

- 2022 End of Year Fund Drive
Tue, Nov 22, 2022
- KiCad 6.0.9 Release
Mon, Oct 31, 2022
- KiCad 6.0.8 Release
Wed, Sep 28, 2022

Type here to search

KiCad (5.1.0)-1 C:\Users\ANMES\123\123.pro

File View Tools Browse Preferences Help

123.pro
123.kicad_pcb
123.sch

Project name:
C:\Users\ANMES\123\123.pro

Type here to search

PROTEUS

Description	Release Date	USC Valid	
Proteus Professional 8.15 SP1 [8.15.34318]	14/11/2022	Yes	Download
Proteus Professional 8.14 SP2 [8.14.32469]	22/07/2022	Yes	Download
Proteus Professional 8.13 SP4 [8.13.32171]	07/01/2022	Yes	Download
Proteus Professional 8.12 SP2 [8.12.31156]	17/06/2021	Yes	Download
Proteus Professional 8.11 SP1 [8.11.30226]	03/11/2020		Download

DIGI XCTU

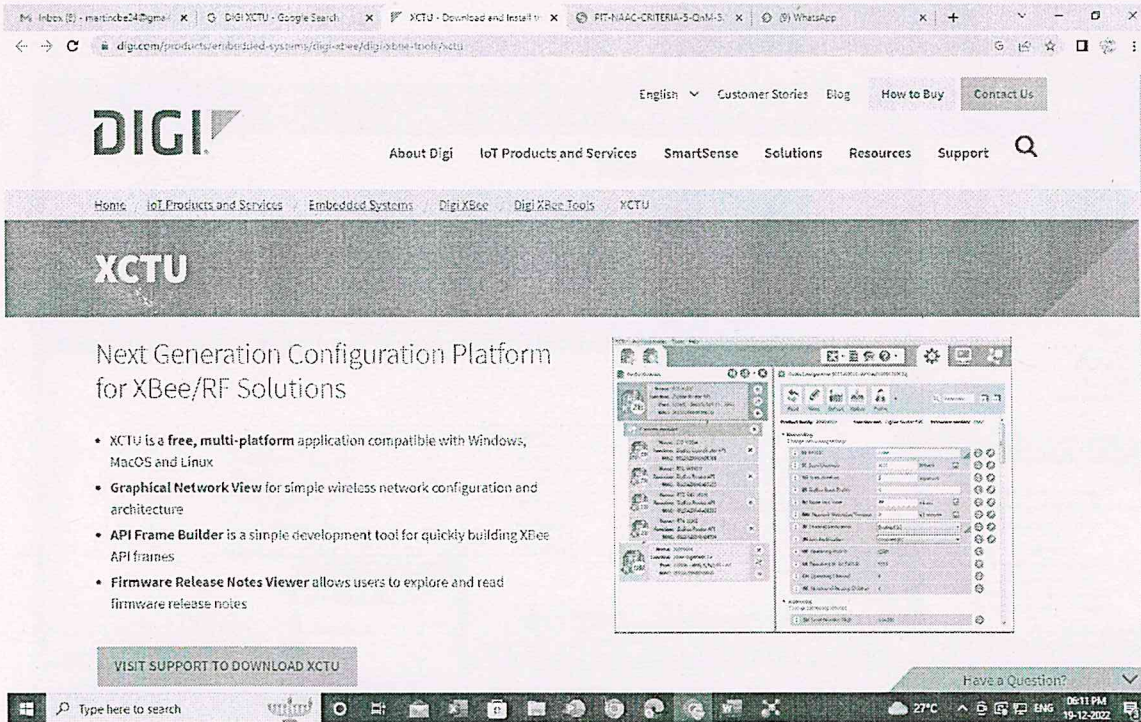
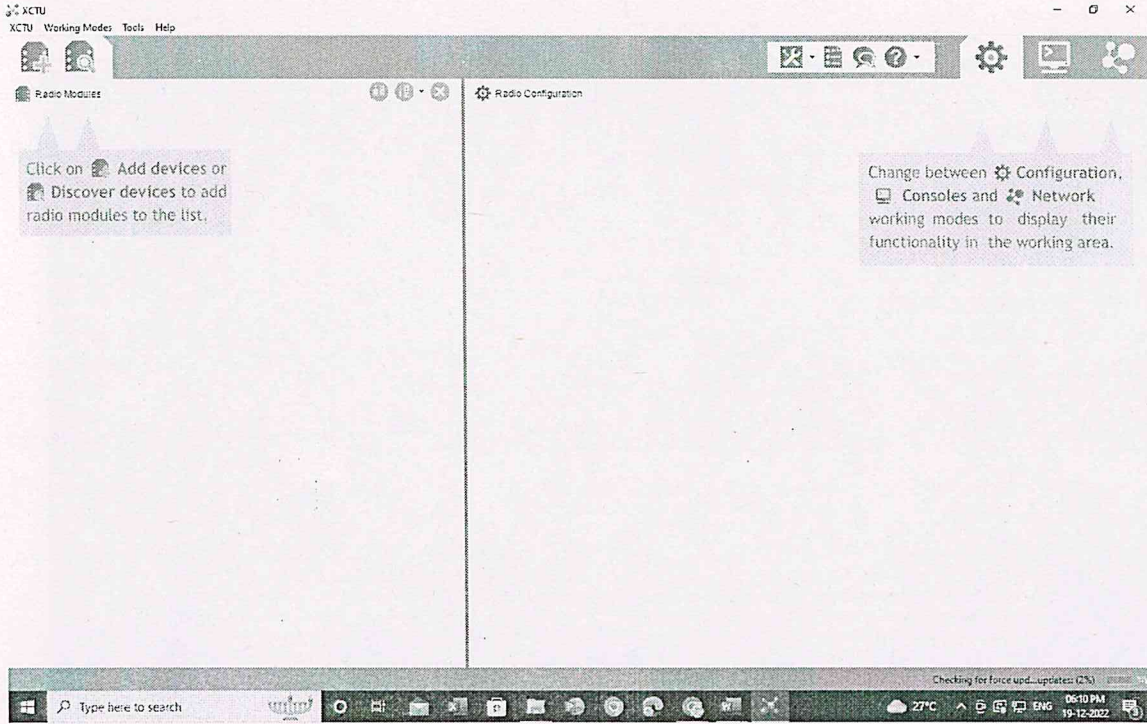



ST. ANNE'S COLLEGE OF ENGINEERING AND TECHNOLOGY
(Approved by AICTE, New Delhi. Affiliated to Anna University, Chennai)
ANGUCHETTYPALAYAM, PANRUTI - 607 106.

DEPARTMENT OF MECHANICAL ENGG.

ANSYS 13.0

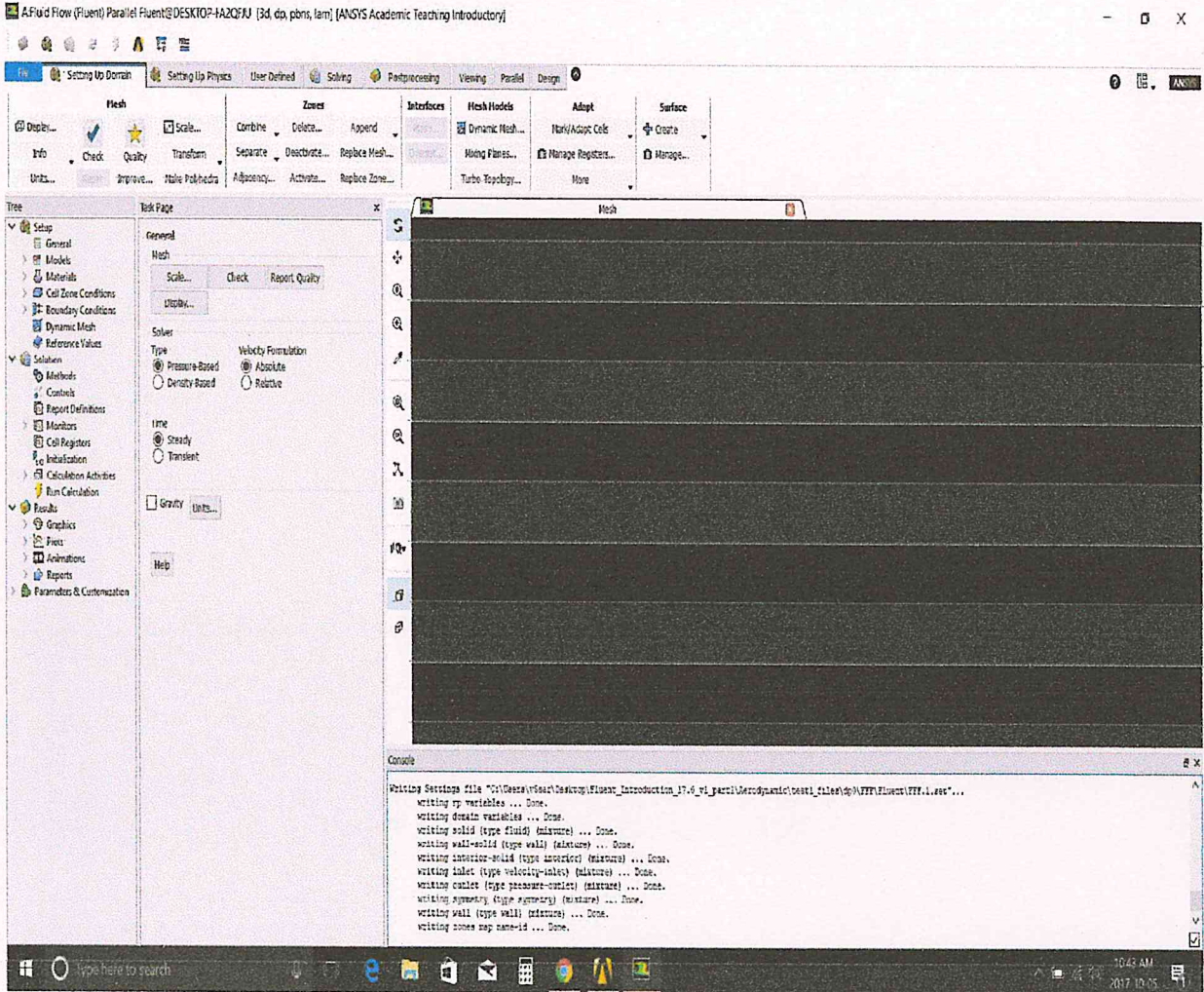

AUTO CAD

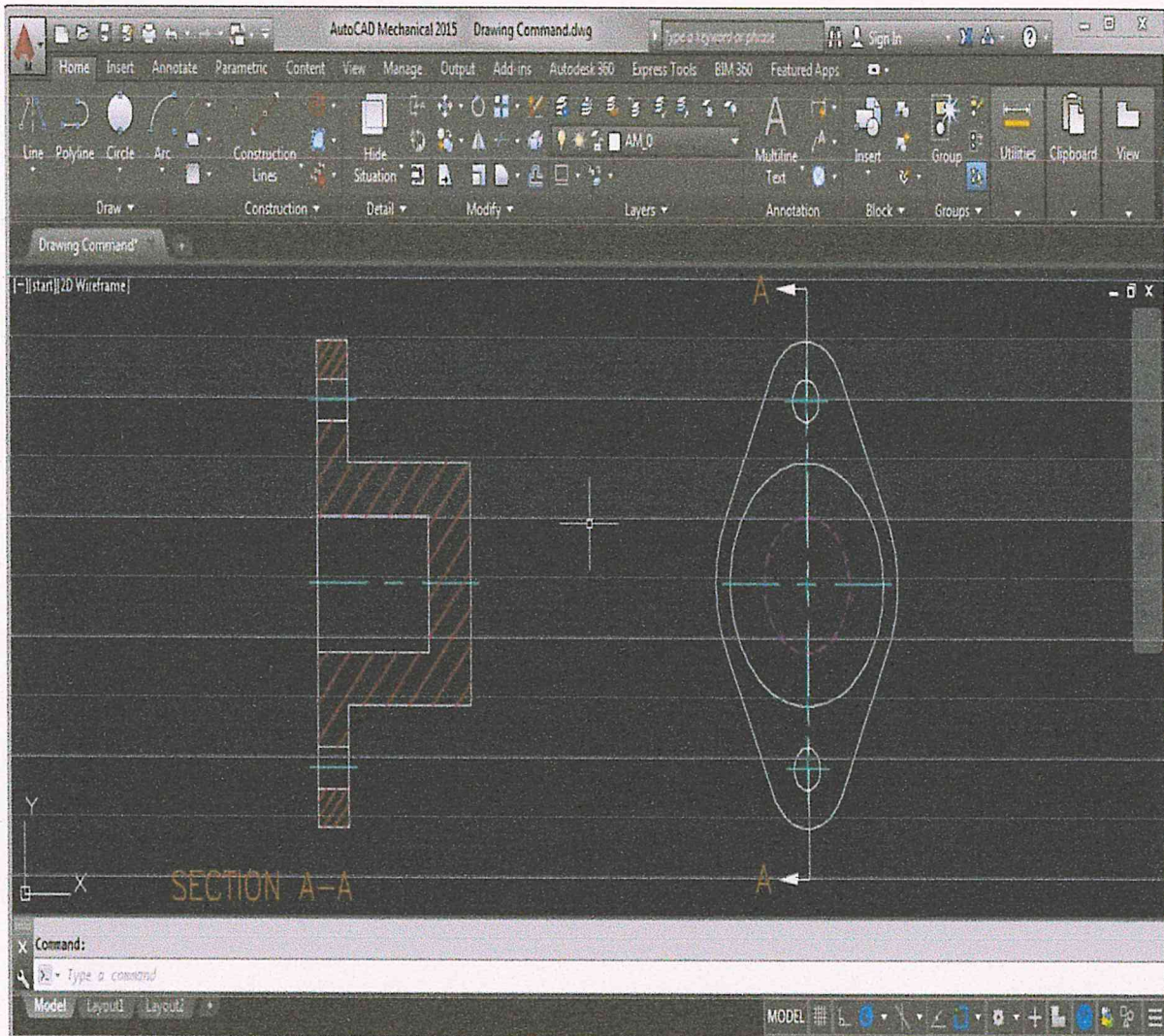

CREO 2.0

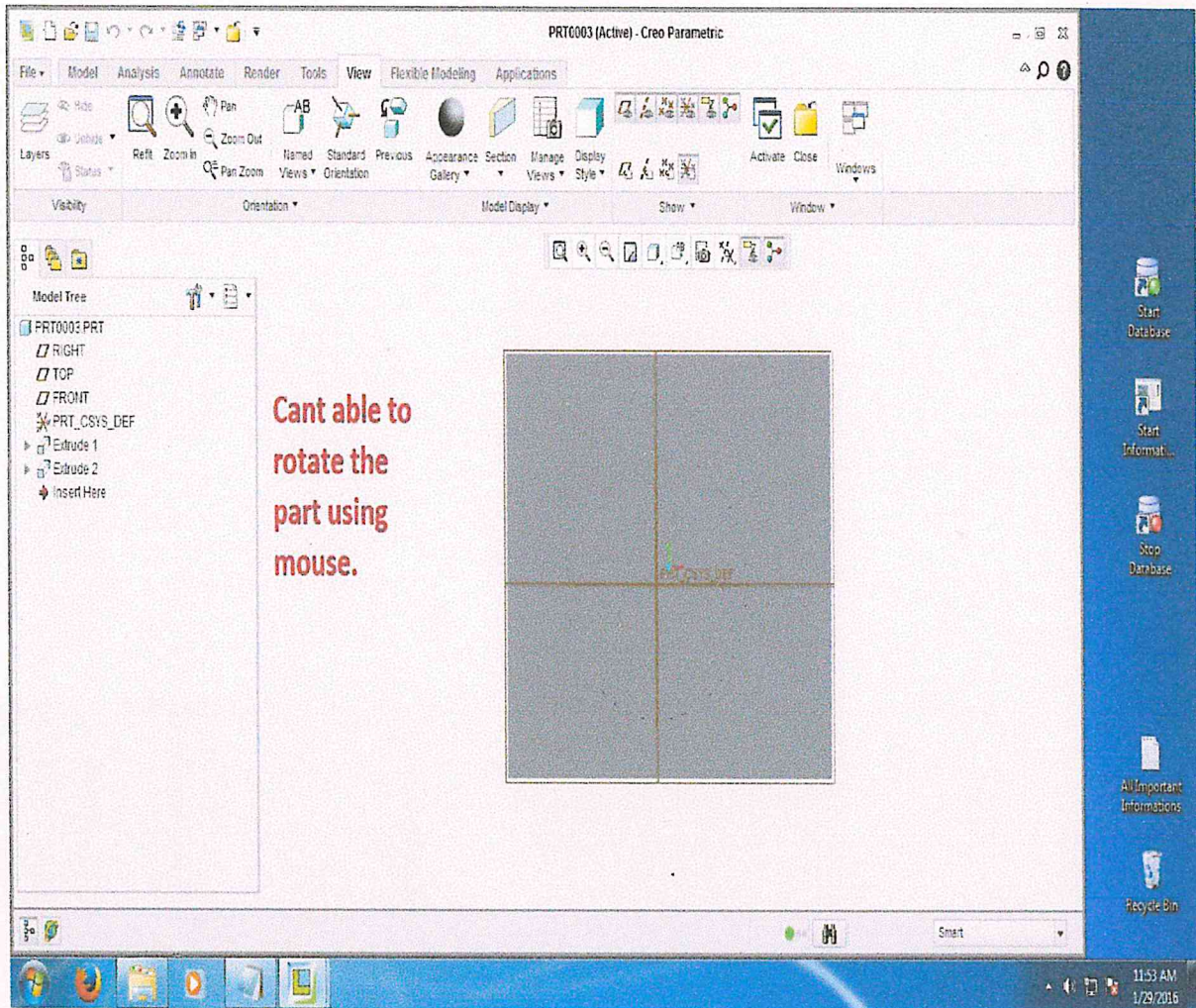

RETAIL INVOICE / CASH MEMO / BILL

MECH - PRO-E

Software

TRIDENT TECHLABS PVT.LTD. White House, IInd Floor, 1/18-20, Rani Jhansi Road, New Delhi-110 055 Ph. No. 91-11-23629285,23629286, Fax 91-11-23629287 Regd. Office : - A-19, Saraswati Garden, New Delhi - 110015 E-Mail :accounts@tridenttechlabs.com	Invoice No.	Dated
	284-D/2013-14	31-Mar-2014
	Delivery Note	Mode/Terms of Payment
	Supplier's Ref.	Other Reference(s)
Buyer St. Anne's College of Engineering & Technology Anguchettypalayam, Siruvathur Post, Panruti Taluk - 607110 Cuddalore District	Buyer's Order No.	Dated
	SACET/Mech/02/13-14	20-Mar-2014
	Despatch Document No.	Dated
	Despatched through	Destination
	Terms of Delivery	

SI No.	Description of Goods	Quantity	Rate	per	Amount
1	Creo Software Download (St. Anne's) 1. Creo Elements /Pro - E (Formerly Pro/Engineers WF 5.0) University Plus Edition Perpetual License with 1 Year Maintenance (Service : Information Technology Software Service)	1 Nos.	4,00,477.00	Nos.	4,00,477.00
	CST 5%			5 %	20,024.00
	Service Tax (On Assessable Amount 4,00,477.00)			12 %	48,057.00
	Education Cess			2 %	961.00
	Secondary and Higher Education Cess			1 %	481.00
	Total	1 Nos.			₹ 4,70,000.00

Amount Chargeable (in words) Rupees Four Lakh Seventy Thousand Only E. & O.E

Company's VAT TIN : 07540231423
 Company's CST No. : 07540231423
 Company's Service Tax No. : AABCT1513DST002
 Company's PAN : AABCT1513D

Declaration
 We declare that this invoice shows the actual price of the goods described and that all particulars are true and correct.

for TRIDENT TECHLABS PVT.LTD.



This is a Computer Generated Invoice

ST. ANNE'S COLLEGE OF ENGINEERING AND TECHNOLOGY

STOCK LEDGER OF CONSUMABLE STORES

Name of Article Creo Software Download (St Anne's)

Date	Name of Supplier / Supply Order No / To Whom issued	Bill No. & Date	Cost of the Item	Qty. Received	Indent No.	Issued	Balance	Remarks
31-03-2014	Trident Techlabs Pvt Ltd, New Delhi	284-D/2013-14	Rs 4,70,000	1 No	(30 users)			
	<p><i>K. Srinivasan</i> 2/04/14 Lab In-charge</p>							<p><i>R. Srinivasan</i> Principal</p>
	<p>The above items are verified and found to be correct</p> <p><i>U. Neelavanya</i> Lab In-charge</p> <p><i>H. Srinivasan</i></p>							<p><i>K.M. Srinivasan</i> 18/4/15 Verification Officer MARTIN LOURDURAS <i>R. Srinivasan</i> Principal</p>

IRON CAD

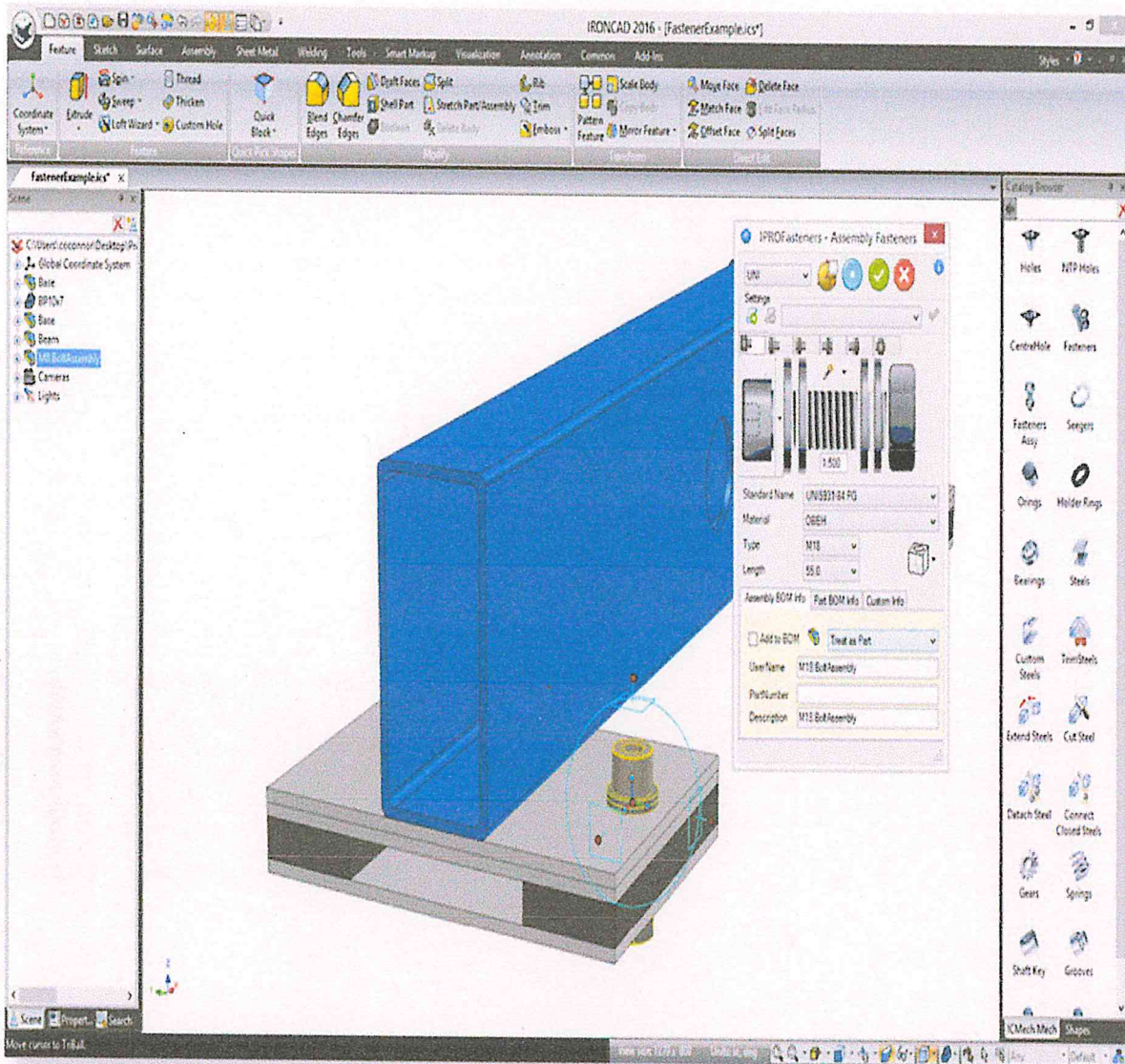

3580441270/96-97
52679

INVOICE

Ph : 044-32583600

NETZONE INFORMATICS

10/21, Maragadam Avenue, Kilpauk, Chennai - 600 010.

SECRETARY,
St. Anne's College of Eng and Techn,
ANNUR

Bill No. : 2094 Date :
Order No. : Date : 15/7/09
Mode : DIRECT
Payment : By CASH

Particulars	Qty.	Unit Price		Amount	
		Rs.	Ps.	Rs.	Ps.
AD SOFTWARE WITH 2D & 3D ANSA PRODUCTIVE SOLID MODELING WITH END USER LICENSE AGREEMENT. [INCLUSIVE OF ALL TAXES] [FOR INFORMATION PURPOSE ONLY]	END USER				10,92,000.00
TOTAL					10,92,000.00/-

For **NETZONE INFORMATICS**

K. Kuri
Authorised Signatory

Received the above in Good condition

S. W. Willy
Secretary

St. Anne's College of Engineering & Technology,
ANGUCHETTYPALAYAM,
Srivathur-Post, Panruti,
Cuddalore-Dist, 605 001

We warrant that the invoice shows the actual prices of the goods described and that the prices are true and correct. | Goods once sold can not be exchanged for warranty claims for mishandling and electricity burnt. | Any complaint with us within 24 hours of receipt of the goods. | In case of banking of cheque, actual bank charges charged by the bank will be as per original Manufacturer's terms. | Disputes are subject to

EDGE CAM 2011

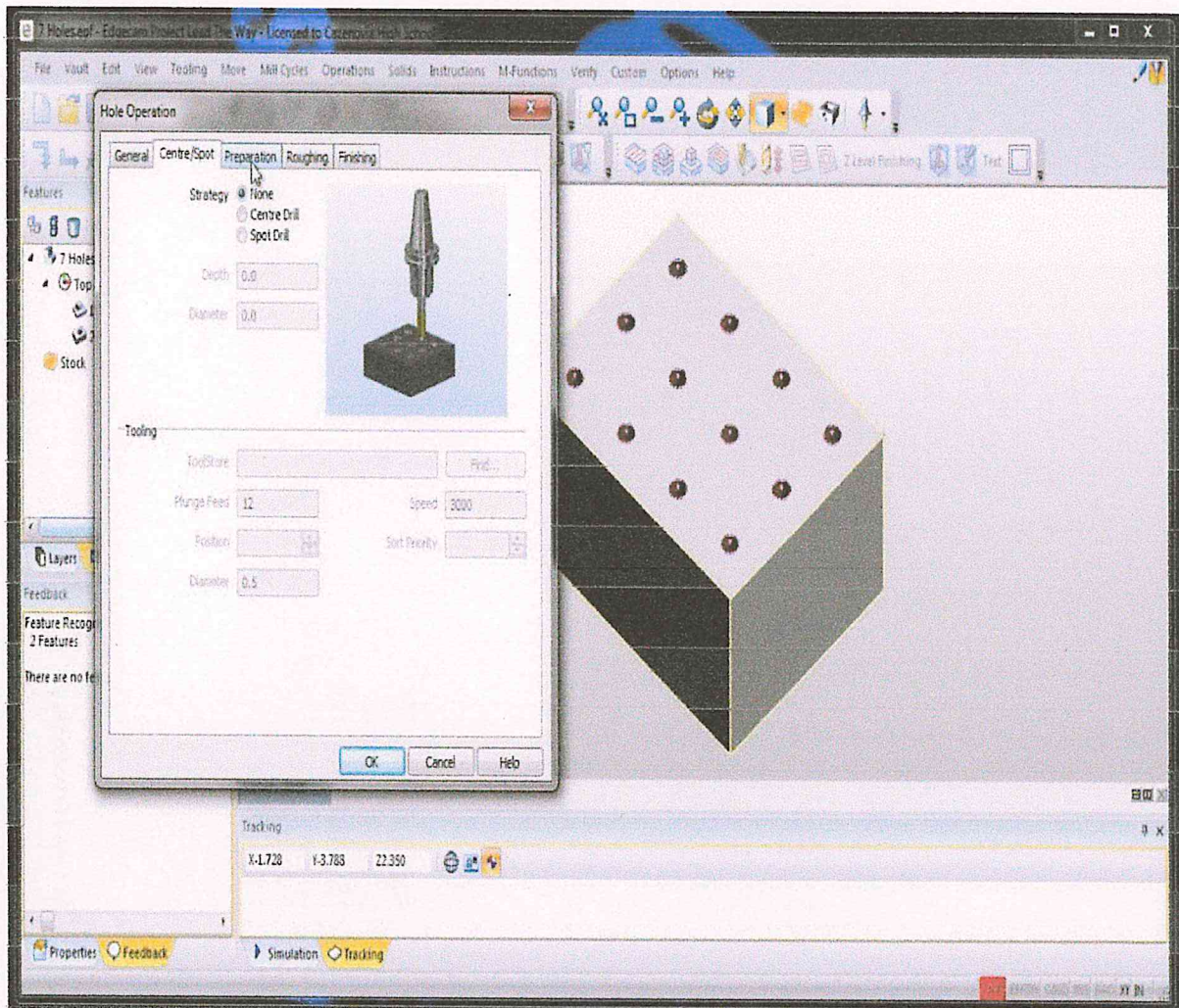

INVOICE

ORIGINAL COPY

**Kriatec Services Private Limited**

45, Second Street, Parthasarathy Nagar
Adambakkam, Chennai – 600 088
Tel : +91 44 4355 9587/4360 4757
Region : CHENNAI

Email: info@kriatecglobal.com

Website : www.kriatecglobal.com

Invoice No.: Kriatec/edgcam/11-12/06/010

Date of Invoice : 02.06.2011

Name and Address of the Buyer :

TO
**ST. ANNE'S COLLEGE OF
ENGINEERING AND TECHNOLOGY**
Anguchettipalayam, Siruvathur Post,
Panruti Taluk – 607 110, Cuddalore Dist
Tel/Fax: 04142-242661,243661

Your Order No. :

Date :

No	Description & Specification of Goods	Qty. Nos.	Rate Per Unit (Rs.)	Total Amount in Indian Rupees
	<u>Computer Application IT Software</u> CAD/CAM Software – Edgcam Software Educational Network License 2011 R1 Type: Keyless Network License <u>Server Code: 6218-1035-5831-0516-9592-8797</u> <u>Serial No.: 1HA-4CY5-AERE-77KB</u> FREE GIFT: CLASSROOM TALKY - MODEL158	15 Seats of Edgcam NC Verify Module for manual part programming simulation + 10 Seats of Edgcam CAD/CAM Module	1,87,500/-	1,87,500/-

Payment Terms :

Sales Tax. No.: CST No.: 985761 VAT TIN No.: 33320 987230
Service Tax No.: AADCK6362PSD001

Total Rs. 1,87,500/-

CST/VAT: 4% Rs. 7,500/-

Service Tax: 0% Rs. 0/-

Our D.C Number & Date:

Freight & Forwarding Rs. 0/-

Total Rupees (in Words) : One Lac Ninety Five Thousand
Only

Total Amount Payable Rs. : 1,95,000/-**RECEIVED BY**

R. S. Srinivasan
Mechanical Department, 4/6/2011
St. Anne's College of Engineering & Technology,
ANGUCHETTIPALAYAM.



For Kriatec Services Private Limited

[Signature]
AUTHORISED SIGNATOR

Siruvathur-Post, Panruti-Taluk,
Cuddalore-Dist, 607 110.

ST. ANNE'S COLLEGE OF ENGINEERING AND TECHNOLOGY

STOCK LEDGER OF ^{NON} CONSUMABLE STORES

Name of Article ... Edgecam Software Educational Network

Date	Name of Supplier / Supply Order No / To Whom issued	Bill No. & Date	Cost of the Item	Qty. Received	Indent No.	Issued	Balance	Remarks
21.06.2011	Kriatec Services	11-12/6/10	Rs	15 Sets				
	Private Limited	08.06.2011	1,95,000	of				
	Chennai - 600 088			Edge				
				Cam				
				No. of				
				Module				
				+				
				10 Sets				
				of				
				Edgecam				
				Cam				
				Module				

CNC TRAINER VERSION 8.01 (OFFLINE SIMULATION)

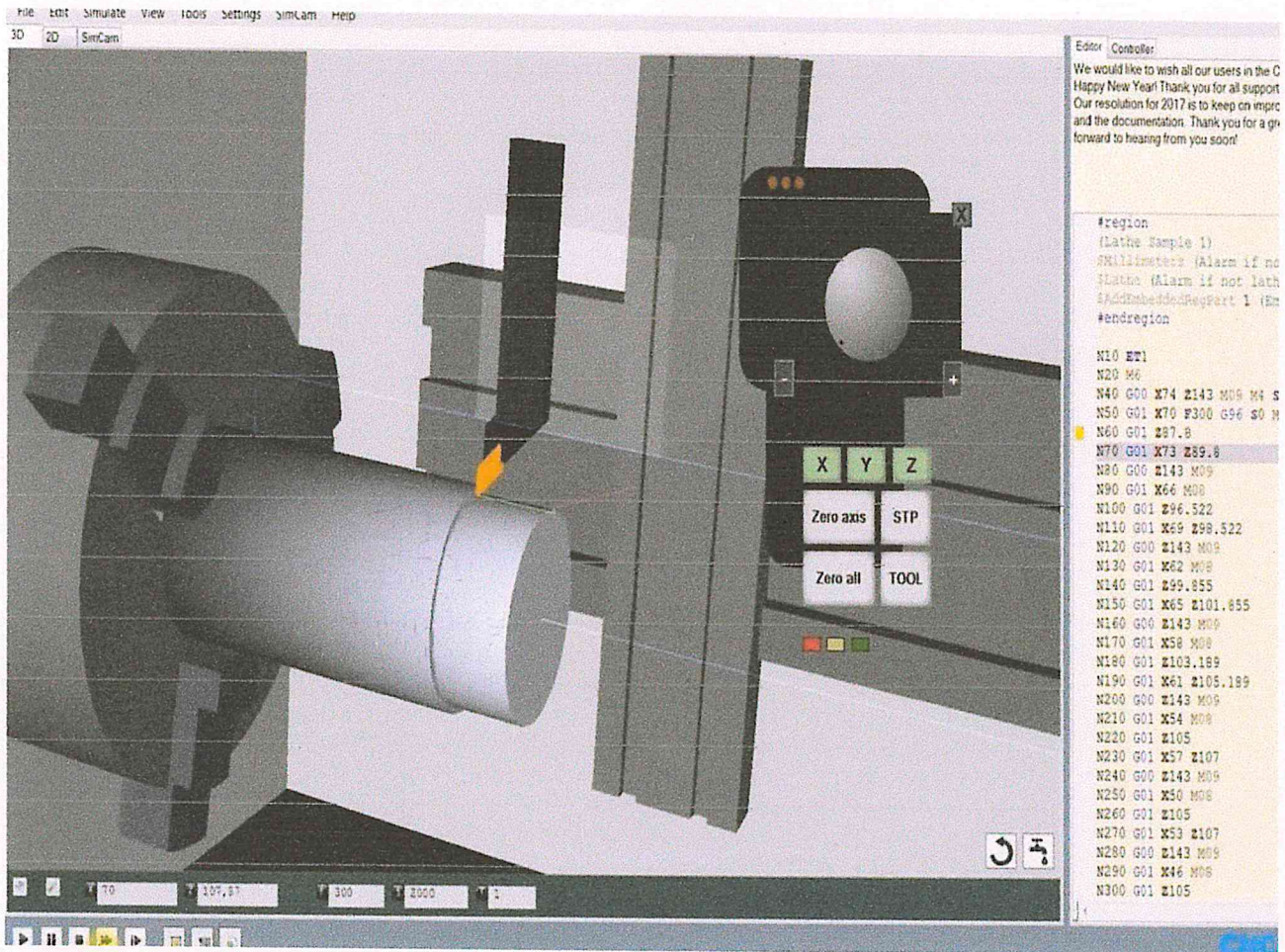

MTAB

To

Sr. Aniba
Bilal

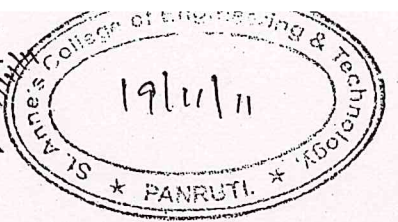

COMMERCIAL INVOICE
(For payment purpose only)

INVOICE NO:054

Dated: 11/11/2011

MTAB ENGINEERS PRIVATE LIMITED Admn. Office 17/1 Thanikachalam Road,
T.Nagar Chennai -600 017 Tel. Nos. 044-24340738/24348590 Web:www.mtabindia.com. Email. mtabindia@eth. net.
Factory: 107 Dev. Plot E & E Industrial Estate, Perungudi, Chennai – 600 096
Telephone Nos. 24961097/24960766 Fax No.044-24960584 Email. adminfactory@mtabindia.com
VAT (TIN) No.33381580449 CST No. 638618 Dt. 11.1.93

Purchase Order No. & date SACET/MECH/04/11-12 DT.09.11.11	Documents DIRECT	PAYMENT As per terms & conditions
--	---------------------	---

INVOICE TO THE PRINCIPAL, ST.ANNE'S COLLEGE OF ENGINEERING AND TECHNOLOGY, ANGUCHETTYPALAYAM, SIRUVATHUR POST, PANRUTI TALUK-607 110.	SHIP TO THE PRINCIPAL, ST.ANNE'S COLLEGE OF ENGINEERING AND TECHNOLOGY, ANGUCHETTYAPALAYAM, SIRUVATHUR POST, PANRUTI TALUK -607 110.
--	---

Transporter BY SIROMANI TRANSPORT	Vehicle No. TN 22 B 3027	LR No. -	No. of package 8 PACKAGES
--------------------------------------	-----------------------------	-------------	------------------------------

Sl.no.	DESCRIPTION	QTY	VALUE IN RS.
1	XLTURN CNC TRAINER LATHE MACHINE WITH STD. EQUIPMENTS MODEL:XLTURN MACHINE NO:456 TOOLING PACKAGE FOR XL TURN	1 NO 1 SET	15,00,000.00
2	XMLL NON- ATC MILLING MACHINE WITH STD. EQUIPMENTS MODEL:XMLL MACHINE NO:448 TOOLING PACKAGE FOR XL MILL	1 NO 1 SET	
TOTAL VALUE (including Duties & taxes)			15,00,000.00

(RUPEES FIFTEEN LAKHS ONLY)

Supporting documents		For MTAB ENGINEERS PVT LTD
1. Excise Inv.No. 0132/11.11.2011	- Rs. 14,15,790.00	 Authorized Signatory
2. Trading Inv. No 101/11.11.2011	- Rs. 42,630.00	
3. Trading Inv. No. 100/11.11.2011	- Rs. 41,580.00	
Total	15,00,000.00	

MACHINE TOOL AIDS BUREAU

#133, Developed Plot, Electrical & Electronics Industrial Estate, Perungudi, Chennai – 600 096 (INDIA)

To
 The Principal
 ST. ANNE'S COLLEGE OF ENGINEERING
 AND TECHNOLOGY
 Anguchettypalayam,
 Siruvathur Post,
 Panruti Talk - 607 110

Invoice No.
 Date : 09/11/2013
 Delivery Challan: 014 Date : 09/11/2013
 Your Order :
 SACET/Mech/01/13-14 Date : 05/11/2013
 Despatch By :

Documents :

Payment

Sl. No.	DESCRIPTION	Quantity	Rate		Amount	
			Rs.	P.	Rs.	P.
1.	CNC Train Offline Simulation Software -15 User Network License (Fanuc OT & Fanuc OM)	1 no	276190	00	276190	00
	ADD: VAT @ 5%				13810	00
	Total				<u>290000</u>	<u>00</u>
	(R PSES TWO LAKHS NINTY TROUSAND ONLY)					
	**ONLY THE LICENSE TO THE APPLICATION BENEFITS ON THE SOFTWARE IS BEING USED TO THE BUYER.					

For MACHINE TOOL AIDS BUREAU

M. Subramanian



FLUID SIM

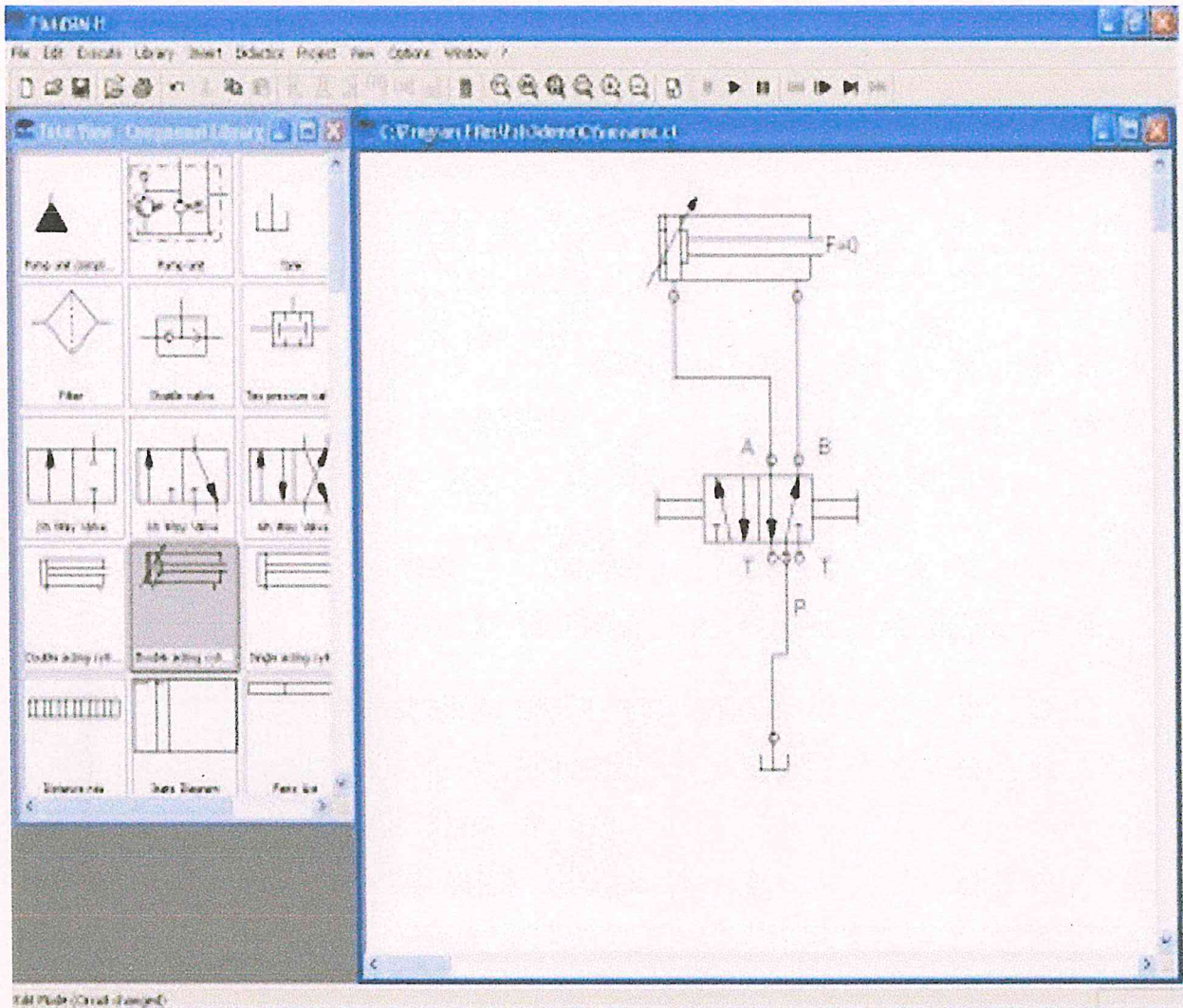

Vi Microsystems Pvt. Ltd.

TIN No. : 33891580314
 AREA CODE : 0810
 C.S.T. No. : 42596

DELIVERY NOTE

Plot No.75, Electronics Estate
 Perungudi, Chennai - 600 096.
 Phone : 24961842 / 52 Fax : 24961536

No.	T/0098	Date :	07-Jul-2012
Our Quotation Ref :		V11/QTN/4414, 25-Jan-2012	
Your Order No.		SACET/MECH/01/12-13, 04-Apr-2012	

To

**THE PRINCIPAL
 ST. ANNE'S COLLEGE OF ENGINEERING &
 TECHNOLOGY
 ANGUCHETTYPALAYAM,
 SIRIVATHUR POST,
 PANRUTI TALUK,
 CUDDALORE - 607 110**

Sl. No.	Description	Quantity	Remarks
1	HYDRAULIC SIMULATION SOFTWARE - FIVE USERS	1	Delivery To DEPT. OF MECHANICAL ENGG.
2	PNEUMATIC SIMULATION SOFTWARE - FIVE USERS	1	

Received the above materials in good condition.
 Quantity verified and found correct.

for Vi Microsystems Pvt. Ltd.



Customer's Signature with seal

Authorised Signatory

Prepared

Checked

INVOICE

Vi Microsystems Pvt. Ltd.

Plot No. 75, Electronics Estate,
Perungudi, Chennai - 600 096.
Sales Ph. : 2496 1842, 2496 1852 Accts. Ph. : 2496 0774
Fax : 2496 1536
E-mail : sales@vimicrosystems.com

TIN No. : 33891580314
AREA CODE : 080
C.S.T. No. : 42596 dt. 6.5.86

<p>THE PRINCIPAL, ST. ANNE'S COLLEGE OF ENGINEERING & TECHNOLOGY, ANGUCHETTYPALAYAM, SIRUVATHUR POST, PANRUTI TALUK, CUDDALORE - 607 110.</p>	No. T/0098	Date : 07/07/2012
	Delivery Note :	
	Order Ref : SACET/MECH/01/12-13, DT: 04/04/2012.	
	Our Ref : V11/QTN/4414, DT: 25/01/2012.	

SL.No.	Description	Quantity	Rate		Amount	
			₹	Ps.	₹	Ps.
AUT ② AUC ③ EX 3.	1. Hydraulic and Pneumatic Software	01	4,20,000	00	4,20,000	00
			Sub Total		4,20,000	00
			Less Discount @ 5%		21,000	00
			Vat @ 5%		3,99,000	00
					19,950	00
					4,18,950	00
Rupees in words			Four Lakhs Eighteen Thousand Nine Hundred and Fifty Only.		Total 4,18,950 00	

Rupees in words

Four Lakhs Eighteen Thousand Nine Hundred and Fifty Only.

Total **4,18,950 00**

for Vi Microsystems Pvt. Ltd.

(Signature)
Authorised Signatory

Subject to Chennai Jurisdiction
E & O. E.

Checked

VERSA PRO

