

DEPARTMENT OF MECHANICAL ENGINEERING

ME 8491 ENGINEERING METALLURGY

Regulation: 2017

Year and Semester: II and IV

OBJECTIVES:

□ To impart knowledge on the structure, properties, treatment, testing and applications of metals and non-metallic materials so as to identify and select suitable materials for various engineering applications.

UNIT I ALLOYS AND PHASE DIAGRAMS 9

Constitution of alloys – Solid solutions, substitutional and interstitial – phase diagrams, Isomorphous, eutectic, eutectoid, peritectic, and peritectoid reactions, Iron – carbon equilibrium diagram. Classification of steel and cast Iron microstructure, properties and application.

UNIT II HEAT TREATMENT 10

Definition – Full annealing, stress relief, recrystallisation and spheroidising – normalising, hardening and Tempering of steel. Isothermal transformation diagrams – cooling curves superimposed on I.T. diagram CCR – Hardenability, Jominy end quench test - Austempering, martempering – case hardening, carburizing, Nitriding, cyaniding, carbonitriding – Flame and Induction hardening – Vacuum and Plasma hardening. .

UNIT III FERROUS AND NON-FERROUS METALS 9

Effect of alloying additions on steel- α and β stabilisers – stainless and tool steels – HSLA, Maraging steels – Cast Iron - Grey, white, malleable, spheroidal – alloy cast irons, Copper and copper alloys – Brass, Bronze and Cupronickel – Aluminium and Al-Cu – precipitation strengthening treatment – Bearing alloys, Mg-alloys, Ni-based super alloys and Titanium alloys.

UNIT IV NON-METALLIC MATERIALS 9

Polymers – types of polymer, commodity and engineering polymers – Properties and applications of various thermosetting and thermoplastic polymers (PP, PS, PVC, PMMA, PET, PC, PA, ABS, PI, PAI, PPO, PPS, PEEK, PTFE, Polymers – Urea and Phenol formaldehydes)- Engineering Ceramics – Properties and applications of Al_2O_3 , SiC, Si_3N_4 , PSZ and SIALON – Composites- Classifications- Metal Matrix and FRP - Applications of Composites.

UNIT V MECHANICAL PROPERTIES AND DEFORMATION MECHANISMS 8

Mechanisms of plastic deformation, slip and twinning – Types of fracture – Testing of materials under tension, compression and shear loads – Hardness tests (Brinell, Vickers and Rockwell), hardness tests, Impact test Izod and Charpy, fatigue and creep failure mechanisms.

TOTAL: 45 PERIODS

OUTCOMES:

□ Upon completion of this course, the students can able to apply the different materials, their processing, heat treatments in suitable application in mechanical engineering fields.

TEXT BOOKS:

1. Avner, S.H., —Introduction to Physical Metallurgy, McGraw Hill Book Company, 1994.
2. Williams D Callister, —Material Science and Engineering, Wiley India Pvt Ltd, Revised Indian Edition 2007

REFERENCES:

1. Raghavan.V, —Materials Science and Engineering, Prentice Hall of India Pvt. Ltd., 1999.
2. Kenneth G. Budinski and Michael K. Budinski, —Engineering Materials, Prentice Hall of India Private Limited, 4th Indian Reprint 2002.
3. Upadhyay. G.S. and Anish Upadhyay, —Materials Science and Engineering, VivaBooks Pvt. Ltd., New Delhi, 2006.

UNIT -1: ALLOYS AND PHASE DIAGRAMS

PART – A

1. What is meant by alloying elements? [M/J 12]

It is a mixture of two or more metals or a metals and a non — metals. The element which is present in the largest proportion is called the base metal, and other element present is called as alloying elements.

2. State Hume rothery's rules? [A/M'15]

Size factor:The atoms must be of similar size, with less than 15% difference in atomic radius

Crystal structure:The material must have the same crystal structure. Otherwise, there is some point at which the transition occurs from one phase to a second phase with different structure.

Valence:The atoms must have the same valence. Other wise the valence electrons difference encourages the formation of compounds rather than solutions.

Electro negativity:The atoms must have approximately the same electro negativity.

3. What is phase diagram?

It is graphical representations of what phase are present in a materials system at various temperatures, pressures, and compositions. And the phase diagrams are also known as equilibrium diagram or constitutional diagrams.

4. State Gibbs phase rule?

It is a simple equation that relates the number of phases presents (P) in a system at equilibrium with the number of degrees of freedom (F), the number of components (C), And the number of non-compositional variables. Gibbs phase rule: $F = C - P + 2$

5. Define critical cooling rate.

The slowest rate of cooling of austenite that will result in 100 percentage martensite transformation is known as critical cooling rate.

6. State the conditions under which two metallic elements will exhibit unlimited solid solutions [A/M'15]

- i) Atomic size - for high solid solubility the atomic size of base metal and alloying must be similar
- ii) Chemical affinity- element having lower chemical affinity have great solid solution.
- iii) Relative valency - for higher solid solubility, the two elements have lower valency should be selected
- iv) Crystal structure - metals with similarly crystal structure have higher solid solubility.

7. Differentiate Isomorphous and eutectic reaction.

Isomorphous is a system with complete liquid and solid solubility zero to hundred percentage When an isomorphous alloy is cooled very, very slowly it undergoes a base change from liquid to solid form.

8. How steels are classified? [N/D'16]

PLAIN CARBON STEEL	ALLOY STEEL
Low carbon steel	Low alloy steel
High carbon steel	High alloy steel
Medium carbon steel	

9. What does a Phase diagram indicate?

The phase diagram indicates the temperature at which the solid alloy will start melting and finish melting.

10. What is the significance of lever rule?

Lever rule is a method used to find out the exact amount of phase existing in a binary system for a given alloy at any temperature under consideration.

11. Define the term solid solutions. [N/D'16]

A solid solution is formed when two metals are completely soluble in liquid state and also completely soluble in solid state.

12. What do you mean by invariant reaction. [N/D'15]

When a reaction occurs under equilibrium condition at a specific temperature and alloy composition that cannot be varied it is said to be invariant.

PART – B

1. With the help of neat sketch explain the two types of solid solution. (M/J2013)

Types of solid solution:

There are two types of solid solutions formed

i) Substitutional solid solution

- (a) Random (Disordered) (b) Ordered

ii) Interstitial solid solution

i) Substitutional solid solution :-

Substitutional solid solutions are formed when some of the solvent atoms (Base metal atoms) are replaced by the solute atoms (alloying elements atoms) in a crystal lattice.

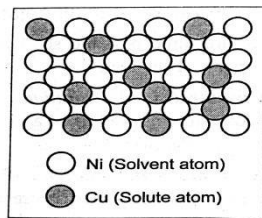

Fig. 1.3. Substitutional solid solution (with nickel atoms substituting for copper atoms on FCC atom sites)

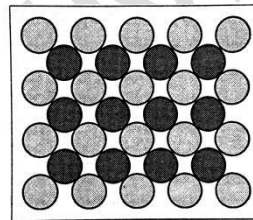

Fig. 1.5. Ordered substitutional solid solution

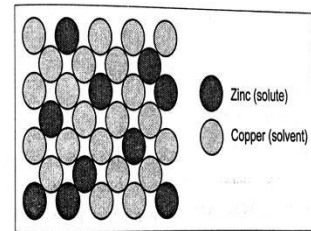

Fig. 1.4. Random substitutional solid solution (zinc in copper, i.e., brass). The crystal pattern is not altered.

Substitutional solid solution occurs when the solute and solvent solution (atoms) are equal or approximately equal in diameter.

Ex: Cu-Ni where Cu has radius of 1.28 Å and Ni has radius of 1.24 Å. Both copper and Nickel have FCC crystal structure. The crystal structure of the solvent is unchanged, But the lattice may be distorted by the presence of solute atoms, particularly if there is significant difference in atoms radii's of the solute and solvent atoms.

a) Random or Disordered substitution solid solution: In Random solid solution, the solute atoms do not occupy any specific position but are randomly distributed in the lattice structure of solvent. The concentrations of the solute atoms vary throughout the lattice structure of the solvent.

b) Ordered Substitutional solution: When the atoms of the solute material occupy similar lattice point with the crystal structure of the solvent material, the solid solution is called ordered solution. During slow cooling, diffusion tends to produce uniform distribution of solute and solvent atoms. The solute atoms move in a definite orderly manner and occupy orderly positions in the lattice. Cu-Zn, Au-Cu, Cu₂MnAl are some examples of ordered structures.

Interstitial solid solution

Interstitial solutions are formed when the solute atoms are very small in comparison with solvent atoms.

The solute atoms occupy the holes(or) interstices between the solvent atoms. Here the solution (or) solute atoms are much smaller than the parent atoms and have occupied randomly in the interstitial voids between parent atoms.

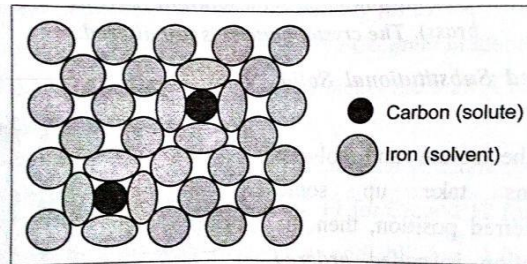

Fig. 1.6. Interstitial solid solution (carbon in FCC iron)

The most important interstitial solid solution present in ferrous metals is ferrite which consists of pure iron containing upto 0.008% carbon at room temperature. In several, hydrogen, carbon, nitrogen and boron having small atomic diameters form interstitial solid solutions with the base metal atoms. Atomic size is not only a parameter which determines whether or not an interstitial solid solution, will form but also small solute atoms like Fe, Ni, Mn, Mo, Cr, W etc dissolve more readily in transition metals.

2. Sketch neatly the ideal iron- carbide binary equilibrium diagram, indicating temperatures, composition and different phases present. Also explain the peritectic reaction of this system. [A/M'15]

- ✓ Iron-Iron carbide equilibrium diagram is very much useful in understanding the microstructures and properties of cast irons and carbon steels
- ✓ It is also used to understand the basic differences among iron alloys and the control of their properties
- ✓ This phase diagram is constructed by plotting the carbon composition (weight percent) along the X- axis and temperature along the Y- axis.
- ✓ The iron-iron carbide (Fe-Fe₃C) phase diagram.
- ✓ This phase diagram presents the phases present at various temperatures for very slowly cooled iron-carbon alloys with up to 6.67% carbon.
- ✓ As discussed in the pure iron exists in three allotropic forms .i.e ,alpha iron,beta iron,comma iron it melts .At room temperature the stable form ,called ferrite exist with a BCC crystal structure. Upon heating, ferrite transforms to FCC austenite at 912 C. This austenite continues till 1394C;at this temperature the FCC austenite transforms back to a BCC phase known as ferrite. Then finally the iron melts at 1538C.All these changes are seen the figure along the left vertical axis of the phase diagram.
- ✓ Carbon is an interstitial impurity in iron and forms a solid solution with each of alpha and beta ferrites ,and also with austenite, as indicated by the alpha,beta,comma single phase fields as shown the figure.

The important information that can be obtained from the Fe-Fe₃C can be studied under the following topics:

- Solid phases in the phase diagram.
- Invariant reactions in the phase diagram.

- Eutectoid, Hypoeutectoid, and hypereutectoid steels.
- Eutectic, hypoeutectic, and hypereutectic cast irons.

Solid phases in the phase Diagram:

The Fe-Fe₃C phase diagram contains the following four solid phases:

1. Alpha Ferrite
2. Austenite
3. Cementite
4. Beta Ferrite

1. Alpha –Ferrite:

- This phase is an interstitial solid solution of carbon in the BCC iron crystal lattice.
 - The solid solubility of carbon in alpha ferrite is a maximum of 0.02% at 723C and decreases to 0.005% at 0C.

2. Austenite:

- The interstitial solid solution of carbon in beta iron is called austenite.
 - Austenite has an FCC crystal structure and a much higher solid solubility for carbon than alpha ferrite.
 - As indicated by fig, the solid solubility of carbon in austenite is a maximum of 2.08% at 1148C and decreases to 0.8% at 723C.

3. Cementite:

- The intermetallic iron-carbon compound is called cementite.
 - Cementite has negligible solubility limits and a composition of 6.67%C and 93.3%Fe.

4. Comma ferrite:

- The interstitial solid solution of carbon in comma iron is called comma ferrite.
- Comma ferrite has a BCC crystal structure.
- The maximum solid solubility of carbon in comma ferrite is 0.09% at 1465C.

Invariant Reactions in the Fe-Fe₃C Phase Diagram: The Three important invariant reactions associated with the Fe-Fe₃C diagram are peritectic, eutectic and eutectoid reactions.

1. Peritectic reaction:

- As this peritectic reaction point, liquid of 0.53%C combines with comma ferrite of 0.09%C to form beta austenite of 0.17%C.
- This peritectic reaction, which occurs at 1495C.
- The peritectic reaction affects only solidification of steels with less than 0.55% carbon.

2. Eutectic reaction: [M/J'16]

- At the eutectic reaction point, liquid of 4.3% forms beta austenite of 2.08%C and the intermetallic compound Fe₃C, which contains 6.67%C.
- This Eutectic reaction, which occurs at 1148C.
- This reaction is of great importance in cast irons.

3. Eutectoid reaction: [M/J'16]

- At the eutectoid reaction point, solid austenite of 0.8%C produces alpha ferrite with 0.02%C and Fe₃C that contains 6.67%C.
- This eutectoid reaction, which occurs at 723C.
- This reaction gains much importance for the heat treatment of steels.

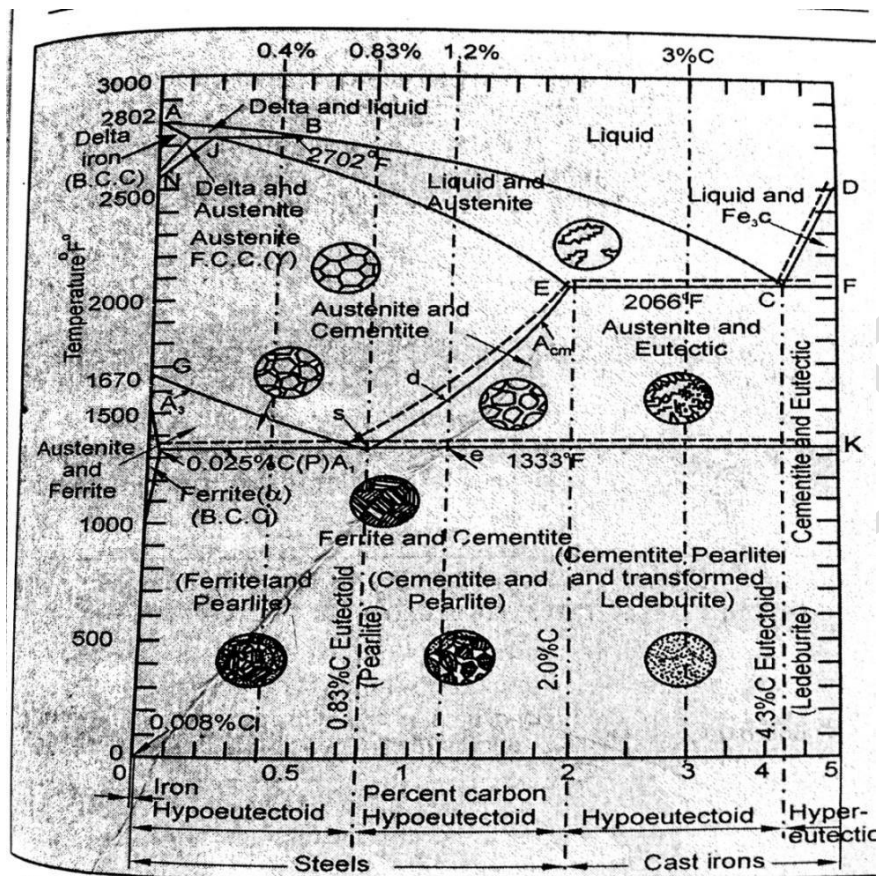

12. (a) Fe-C

Iron carbon equilibrium diagram indicates the phase changes that occur during heating and cooling and the nature and amount of the structural components that exist at temperature besides it establishes a correlation between the micro structure and properties of steel and cast irons and provides a basic for the understanding of the principles of heat treatment.

3. Discuss the classification, micro structure properties and application of steel[M/J'16]

Steel : Steels are alloys of iron and carbon. However steels contain other elements like silicon , manganese, sulphur, phosphorus, nickel etc.

The alloying elements are either intentionally added or retained during the refining process.

Specification of steels:

The American Iron and steel institute the society of Automotive Engineers. American society for testing and materials are responsible for the classification and specification of steels as well as other alloys.

The AISI / SAE designation for the steels is s four digit number:

First two digit indicate the alloy content, and last two digit indicate the carbon concentration.

Classification of steel:

Steel can be classified as follows

1. Plain carbon (or) non alloy steels
 - (i) Low carbon steels
 - (ii) Medium carbon steels

- (iii) High carbon steels2,
Alloy steels
 - (i) Low alloy steels
 - (ii) High alloy steels

Plain carbon steels:

Plain carbon steels are those in which carbon is the alloying element that essentially controls the properties of the alloys and in which the amount of manganese cannot exceed 1.65% and the copper and silicon contents each must be less than 0.6%. **Composition of plain carbon steels:**

Carbon upto 1.5% Manganese upto 1.65% Copper upto 0.6% Silicon upto 0.6%

Other names: the plain carbon steels are also known by many terms such as carbon steels, non alloy steels and straight carbon steels.

Characteristics of plain carbon steels:

- Plain carbon steels are the moderately priced steels due to the absence of large amount of alloying elements.
- They are sufficiently ductile to readily formed.
- Plain carbon steels are available in almost all product forms: sheet, strip, bar, plated, pipe, wire.

Applications of plain carbon steels

- Plain carbon steels are used for mass production products such as automobiles and appliances.
- They also find applications in the production of ball bearings base plates housing, chutes, structural member etc.

Classification of plain carbon steels:

- Low-carbon steel: those containing between 0.25 and 0.6% carbon.
- Medium-carbon steels: those containing between 0.25 and 0.60% carbon.
- High-carbon steels: those containing more than 0.6% carbon.

Low carbon steels:

- The low carbon steels represent the largest tonnage of all the steel produced.
- The low-carbon steels are those steels that contain less than about 0.25% carbon.
- The low-carbon steels are also known as mild steels.

Characteristics of low carbon steels:

- Low carbon steels are relatively soft and weak.
- They can not be hardened appreciably by heat treatment.
- They possess good formability and weldability.
- Strengthening of low carbon steels are accomplished by cold work.
- They have outstanding ductility and toughness.
- The micro structure of low carbon steels consist of ferrite and pearlite constituents.
- Of all steels, the low carbon steels are the least expensive to produce.

Medium carbon steels:

- Medium carbon steels are those steels that have between 0.25 and 0.60% carbon.
- The medium carbon steels may be heat treated, quenched and then tempered to improve their mechanical properties.

Characteristics of medium carbon steels:

The main properties of medium carbon steels are:

1. The plain medium-carbon steels have low hardenabilities.

2. In plain medium carbon steels the high strength and hardness properties are achieved.

Application of medium carbon steels:

The medium carbon steels include railway wheels, railway tracks, gears, crankshafts, and other machine parts.

HIGH-CARBON STEELS:

High carbon steels are those steels that have more than 0.6%.

Characteristics of high carbon steels:

- High carbon steels are the hardest, and strongest of the carbon steels.
- They are the least ductile of the carbon steels.
- They have more wear resistant.
- They are capable of holding a sharp cutting edge (which is very important properties for making tools).

Application of high carbon steels:

The plain high carbon steels in clued cutting tools and dies (for forming and shaping materials) knives, razors, hack saw blades, springs and high strength wire.

Compositions:

Dead mild steel – 0.05 Mild steel - 0.08 – 0.15 Mild steel – 0.5 Mild steel – 0.1-0.3

Alloy steels: In general terms, alloy steels mean any steels other than carbon steels. The steel products manual defines alloy steels as steels that steels.

Manganese -1.65, silicon – 0.6%, copper – 0.6%

Alloying elements:

The most commonly used alloying elements are chromium, nickel, molybdenum, vanadium, tungsten, cobalt, boron, copper and others.

Purpose of Alloying:

- To increase its strength
- To improve hardness
- To improve toughness
- To improve resistance to abrasion and wear
- To improve Machinability
- To improve ductility
- To achieve better electrical and magnetic properties

Classification of Alloy steels:

Alloy steels can be divided into two main groups.

1. Low alloy steels: these contain up to 3 to 4% of alloying elements.
2. High alloy steels: These contain more than 5% of alloying elements.

Low Alloy Steels:

- Low alloy steels are steels which contain up to 3% to 4% of one or more alloying elements.
- They have similar microstructure and require similar heat treatments to that of the plain carbon steel.
- They are also referred as pearlitic alloy steels as the normalised structure contains the eutectoid pearlite.

Types of low alloy steel:

AISI steels and HSLA steels.

AISI steels:

- American Iron and steel institute are steels that are generally used in machine construction.
- AISI steels are sometimes also referred as construction steels or structural steels.
- AISI steel normally have less than about 5% total addition of elements such as Cr, Ni, Cu, Mn, Mo, V etc.

HSLA steels:

HSLA (high strength low alloy) steels, also known as micro alloyed steels, have been developed by making micro alloying additions of the elements Al, Nb and V either singly or in combination to give a major grain refinement.

High Alloy steels:

- High alloy steels are steels which contain more than 5% of one or more alloying elements.
- They have different microstructure and require different heat treatment than that of the plain carbon steels.
- The room temperature structures after normalizing may be austenitic, martensitic or contain precipitated carbides.

Types of high alloy steels:

- Tool and die steels-high quality
- Stainless steel to improve corrosion resistance.

4. Discuss the composition, Properties and applications of the following cast iron. [M/J'16]

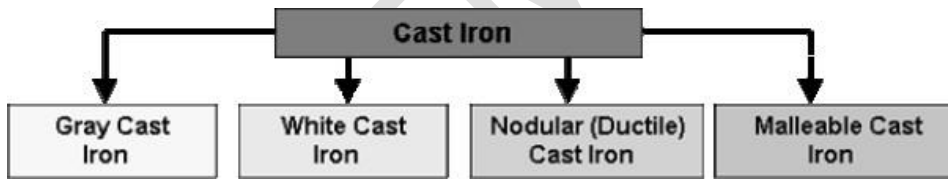

(i) Malleable cast iron

(ii) Spheroidal cast iron

Malleable cast iron:

Malleable iron is a cast iron that has been heat treated so that it has significant ductility and malleability.

Composition:

The composition of a typical malleable cast iron is given below

Carbon – 2.0% to 3.0% Manganese-0.2% to 0.6% Silicon – 0.6% to 1.3% Phosphorus-0.15% Sulfur-0.10%

Micro structure of malleable cast iron

Malleable iron is produced by heat treating unalloyed (2.5% C, 0.5% Si) white iron. During the heat treatment process, the cementite in the white cast iron structure breaks down into ferrite and graphite clumps (or) nodules. This graphite nodule, also called tempered carbon, appears like popcorn. This graphite shape permits a good combination of strength and ductility in the pearlite matrix. The irons so produced are called pearlite.

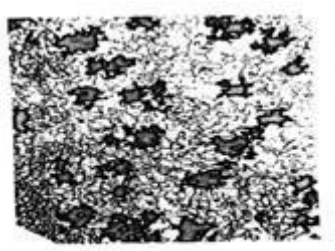

Microstructure of malleable cast iron

Designation of malleable cast iron

The designation system for malleable cast iron given by ASTM, is a five digit number. The first three digits represent the minimum yield strength in Psi of the iron, and the last two digits represent the percent of elongation.

A grade 32510 malleable cast iron has a minimum yield strength of 32.5×10^3 ,Psi and 10% elongation, and a grade 35018 a minimum yield strength of 35×10^3 psi = 242 Mpa) and 18% elongation.

Characteristic of malleable cast iron:

The important properties of malleable cast iron are given below:

The malleable cast iron possesses good ductility and malleability properties than grey cast iron.

It exhibits high yield strength and tensile strength. It is not brittle as grey cast iron.

It has high young's modulus and low co-efficient of thermal expansion. It has good wear resistance and vibration damping capacity.

It also has excellent Machinability

Types malleable irons:

Two types of malleable irons, depending on the type of heat treatment cycle used to produce, are

1. Ferritic Malleable iron
2. Pearlitic malleable iron

1. Ferritic malleable iron:

The white iron castings are heating beyond the upper critical temperature and held for a prolonged period of time so that carbon in the cementite converts to graphite, subsequent low cooling through the eutectoid reaction results in a ferrite matrix. The cast iron so obtained is termed as ferritic malleable cast iron. The ferritic malleable cast iron has good toughness compared with the of other cast iron.

2. Pearlitic malleable iron:

When the white cast iron is cooled from temperature higher than a upper critical temperature more rapidly through the eutectoid transformation range, the carbon in the austenite will not have enough time to form additional graphite but is retained.

Application of malleable iron:

Automobile industries because of their combination of castability , shoukresistance, and good Machinability. Typical components in clued brake-shoes , pedals, levers, wheel hubs, axle housing, connecting rods, transmission gears, and door hinges. **Spheroidal graphite or nodular cast iron:**

Spheroidal graphite cast iron is also known as nodular iron or as ductile iron.

Compositition:

The composition of a typical cast iron is given below Carbon -3.2 to 4% Silicon -1.8 to 3% Manganese-0.01% max

The SG iron is the cast iron with nodular or spheroidal graphite. The nodules also called spheroids are

about the same as those in malleable cast iron, except that they are more perfect spheres.

Micro structure of SG cast iron

The nodular cast iron is produced by adding magnesium and or cerium to molten cast iron (ie the gray iron before casting) The magnesium converts the graphite of cast iron from flake form into spheroidal or nodular form. The resulting alloy is called spheroidal or nodular cast iron.

The presence of spheroidal graphite improves the ductility strength, fracture toughness, and other mechanical properties. Ductility cast iron derives its name from the fact its ductility is increased by 20%. Addition of magnesium gives good results and hence it is widely used.

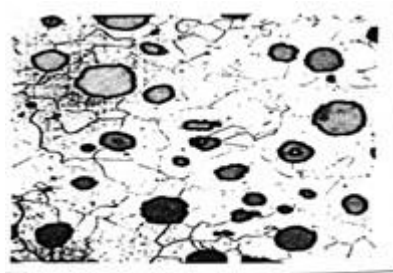

Microstructure of a nodular iron

Magnesium is usually added in the form of a master alloy such as ferrous silicon magnesium or nickel magnesium alloyed: a grade 60-40-18 SG cast iron has a minimum tensile strength of 60×10^3 psi, minimum yield strength of 40×10^3 psi and 18% elongation.

Characteristics of SG cast iron

- (i) It has good toughness than the grey cast iron.
- (ii) It good fatigue strength.
- (iii) It exhibits good impact strength.
- (iv) It possesses good hardness and high modulus of elasticity.
- (v) It has corrosion resistance similar to that of gray iron.
- (vi) It possesses excellent castability and wear resistance.
- (vii) It has ability to resist oxidation at high temperatures.
- (viii) It has good machinability.

Application of SG cast iron:-

The typical applications of SG cast iron include valves, pump, bodies, crankshaft, gears, pinions, rollers, rocker arms, flanges, pipe fittings, power transmission equipments, earth moving machineries and other machine components.

PART-C

1. Explain: [N/D'16]

1. Eutectic reaction (4)
2. Eutectoid reaction (4)
3. Peritectic reaction (4)
4. Peritectoid reaction (4)

Eutectic reaction:

A eutectic reaction is a three-phase reaction, by which, on cooling, a liquid transforms into two solid phases at the same time. It is a phase reaction, but a special one. For example: liquid alloy becomes a solid mixture of alpha and beta at a specific temperature (rather than over a temperature range). The eutectic solid is commonly lamellar (stripy) in form.

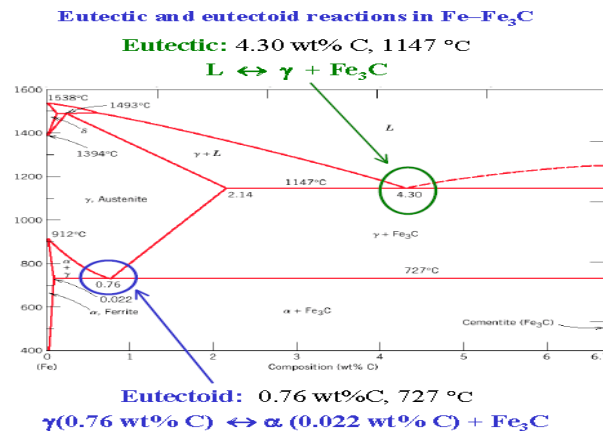

Eutectoid reaction:

The eutectoid reaction describes the phase transformation of one solid into two different solids. In the Fe-C system, there is a eutectoid point at approximately 0.8wt% C, 723°C. The phase just above the eutectoid temperature for plain carbon steels is known as austenite or gamma. We now consider what happens as this phase is cooled through the eutectoid temperature (723°C).

Peritectic Reaction:

A peritectic reaction is a reaction where a solid phase and liquid phase will together form a second solid phase at a particular temperature and composition - e.g.

Liquid + alpha --> beta

These reactions are rather sluggish as the product phase will form at the boundary between the two reacting phases thus separating them, and slowing down any further reaction. Peritectics are not as common as eutectics and eutectoids, but do occur in some alloy systems. There's one in the Fe-C system.

Diagram showing the Peritectic reaction, where a liquid and solid together form a new solid phase.

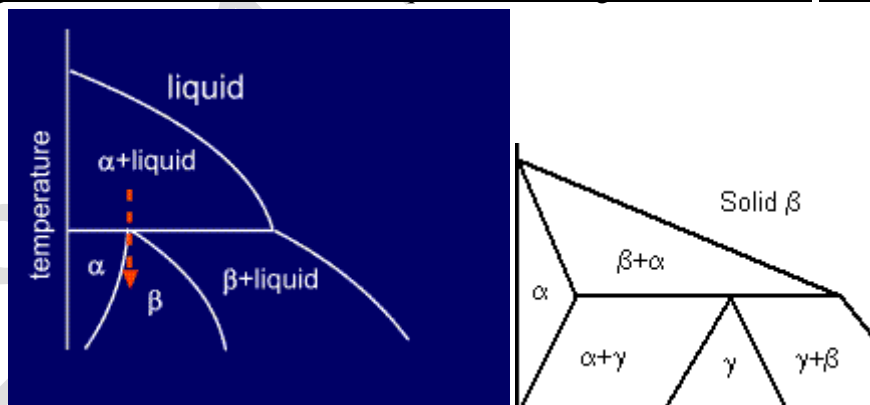

Peritectoid reaction:

A three-phase reaction in which, upon cooling, two solid phases transform to give a third solid phase.

2. Explain the procedural steps for constructing the binary phase diagram where the components show complete liquid and solid solubility. Draw the labelled diagram and name the system. Give one example for the alloy system showing above mentioned behaviour.

Phase diagram for completely soluble Metals (Two metals completely soluble in the liquid and solid state)

- A mixture of two metals is called **binary alloy**
- In some binary alloy system, the two elements are completely soluble in each other in both the liquid and solid states. In these system only a single type of crystal structure exists for all composition of the components, and therefore they are called **isomorphous systems**.
- The equilibrium phase diagram for the isomorphous system is given below

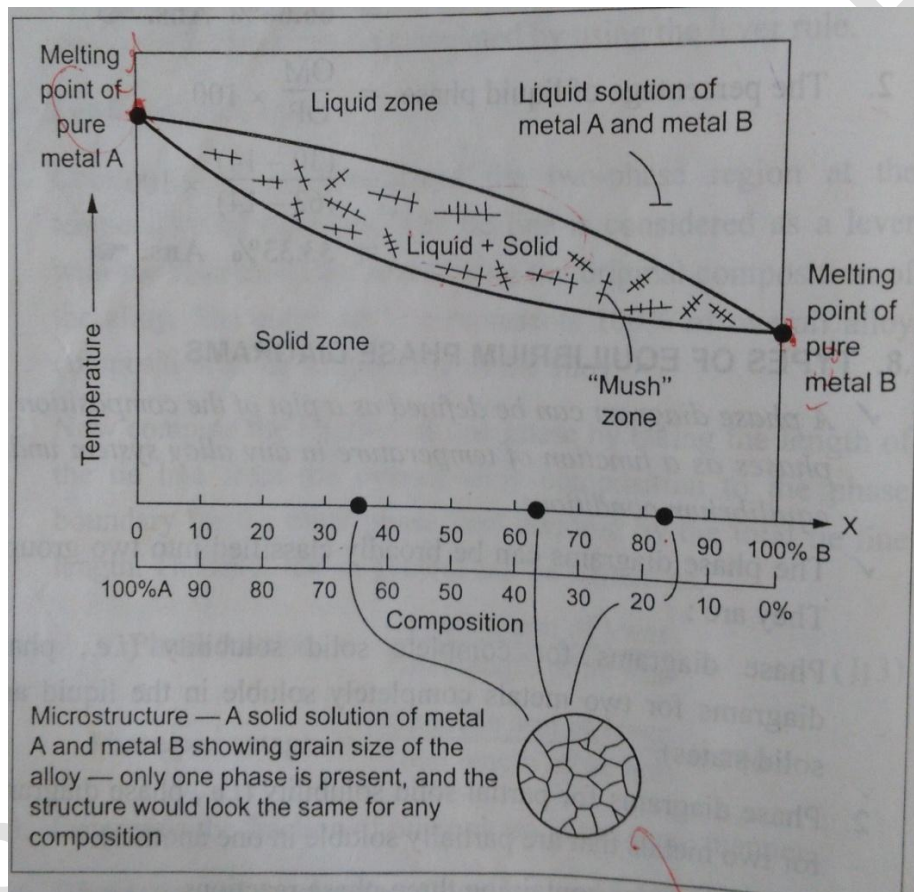

The common examples of isomorphous system are:

1. Copper -Nickel (Cu-Ni) system
 2. Antimony- Bismuth (Sb-Bi) system
 3. Gold -Silver (Au-Ag) system
 4. Chromium -Molybdenum (Cr-Mo) system
 5. Tungsten - Molybdenum (W-Mo) system
 6. Copper -Gold (Cu - Au) system
- The phase diagram is divided into three separate areas by two phase boundaries namely the liquid and solidus.

- Above the liquid there is a uniform liquid solution, while below the solidus, there is a single solid solution. Between the liquids and solidus, both liquid and solid solution coexist.
- Unlike pure metals, alloy freeze over a range of temperature and that the region between the liquids and solidus curves represents the temperature interval during which the alloy are in a pasty condition.

ME8491 EM SACET

UNIT – 2 HEAT TREATMENT

PART: A

1. Define heat treatment process?

Heat treatment process may be defined as an operation or combination of operation involving heating and cooling of a metal/alloy in the solid state to obtain desirable properties.

Purpose of heat treatment process

- To relieve internal stress.
- To improve machinability.
- To improve hardness of the metal surface.
- To increase resistance to wear, heat and corrosion

2. List any two factors that affect hardenability of steels.

- i) Composition of steel
- ii) Critical cooling rate
- iii) Presence of alloying element
- iv) Presence of complex carbides
- v) Homogeneity of austenite

3. What is mar tempering?

Mar tempering, also known as mar quenching, is a interrupted cooling procedure used for steels to minimize the stresses, distortion and cracking of steels that may develop during rapid quenching.

4. What is quenching?

Quenching refers accelerated cooling. The cooling can be accomplished by contact with a quenching medium which may be a gas, liquid or solid. Most of the times, liquid quenching media is widely used to achieve rapid cooling.

5. What are the different processes of surface hardening? [N/D'15]

- i) DIFFUSION METHOD
 - Carburizing
 - Nitriding
 - Cyaniding
 - Carbonitriding
- ii) THERMAL METHOD
 - Flame hardening
 - Induction hardening

6. What is meant by recrystallisation?

Recrystallisation is a process by which distorted grains of cold-worked metal are replaced by new, strain-free grains during heating above a specific minimum temperature.

7. Differentiate carburizing and nitriding.

Carburizing, or carburization is a heat treatment process in which iron or steel absorbs carbon liberated when the metal is heated in the presence of a carbon bearing material, such as charcoal or carbon monoxide, with the intent of making the metal harder.

Nitriding is a heat treating process that diffuses nitrogen into the surface of a metal to create a case-hardened surface. These processes are most commonly used on low-carbon, low-alloy steels.

8. What are the types of heat treatment processes?

The important heat treatment processes are

1. Annealing
2. Normalizing
3. Hardening
4. Tempering
5. Aus tempering
6. Mar tempering
7. Case hardening

9. What do you mean by the term case hardening?

In many applications, it is desirable that the surfaces of the components should have high hardness, while the core or inside should be soft the treatments given to the steel to achieve this is called case hardening.

10. List any two factors that affect hardenability of steels.

Grain Size and Chemical Composition

11. What is austempering? [A/M'15]

- Austempering is a type of interrupted quenching that forms bainite structure.
- It is an isothermal heat treatment process used to reduce quenching distortion and to make a tough and strong steel.

12. Differentiate Annealing and normalizing [A/M'15]

Annealing	normalising
Cooling is established in the furnace	Cooling is done in still air
Provides coarse grain structure	Provides fine grain structure
Temperature is lower than normalising temperature	Temperature is higher than annealing temperature
Process is costly	Process is economical

PART: B

1. Explain the short notes on Annealing

Various heat treatment processes for steels are classified as follows

- i) Annealing
- (ii) normalizing
- (iii) hardening
- (iv) tempering

Annealing :

Process of heating a metal which has a distorted to structure to sufficient high temperature remove all distortion subsequent cooling that microstructure metal is free from any strain and distortion at room temperature.

Full annealing, spheroidising annealing, stress relief annealing, recrystallisation annealing

FULL ANNEALING:

Purpose: it is used to improve ductility, remove internal stress, enhance magnetic and electrical and refine grain structure properties.

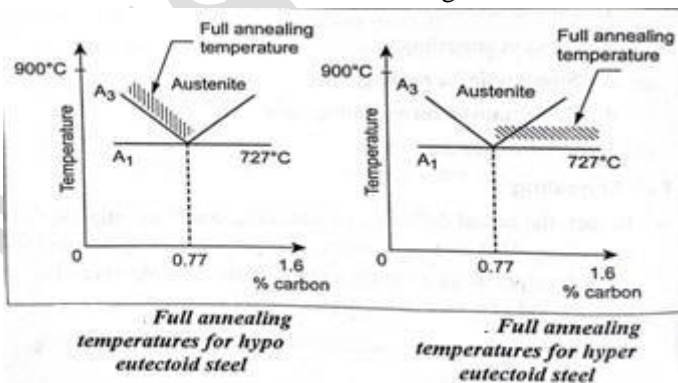

Method : 1. heating the steel to austenitic region

2. Followed by slow cooling

3. Steel is heated above the upper critical temp for hypo eutectoid steels. 4. Above the lower critical temp for eutectoid

Structural change:

- Steel is heated lower critical pearlite changes to fine austenite crystal.
- As temp varied courses ferrite dissolved and disappears at upper critical temp.
- Subsequent furnace cooling ferrite and pearlite for hypoeutectoid steel.
- Pearlite for eutectoid steel.
- Properties based on size of pearlite and ferrite and their relation
- Small size better distribution of ferrite and pearlite
- Rate of cooling affect the size of ferrite and pearlite grains
- Slow cooling large rounded ferrite crystal formed and evenly distributed.
- Higher rate of cooling small ferrite crystals is produced with fine pearlite in the centre.

Application:- This treatment improves the machinability of medium carbon steels.

Limitations:- This process is not employed for hypoeutectoid steel.

SPHEROIDISING ANNEALING:

Purpose: Improve machinability and ductility of high carbon steel and air hardening alloy steels.

Various methods are available to produce spheroidising structure.

First method: Heating the steel just below lower critical temperature holding at that temperature for a prolonged.

Second method: Heating and cooling steel alternately just above and below the lower critical temperature.

Third method: Heating a steel to a temperature above the lower followed by slow cooling to temp below lower at that temp holding critical temp for a long time.

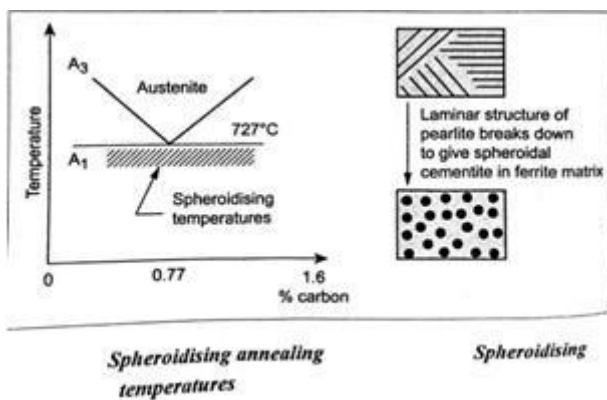

Structural change:

- No phase change takes place.
- Lamellar and free cementite coalesces into tiny spheroids due to surface tension effect.
- Final structure consists of spheroids of carbide in a matrix of ferrite.

2. Write short notes stress relief annealing, recrystallisation annealing STRESS

RELIEF ANNEALING:

Purpose:

- Residual stresses are induced during like solidification of castings, forming, machining, welding, grinding and phase transformation.
- Steel with residual stress fail stress corrosion cracking under corrosion environment.
- These stresses entrance war page and dimensional instability in steels.
- To eliminate or reduce steel is subjected to stress relief annealing. Methods:
- Steel heated uniformly below the lower critical temp and held at sufficient period of time followed

by uniform cooling.

- Magnitude of stress relieved depend on temp and holding time.
- Structural change:
- Steel is heated below lower critical temp.
- Only residual stress relieved.
- No microstructure changes.

Recrystallisation annealing:

Purpose:

- Cold working of steel increase the hardness and decreases ductility.
- Grains are deformed and residual stresses are induced.
- Necessary to soften the material to improve ductility for further cold working.
- Annealing process is employed for this is referred to as recrystallisation.

- Method:

- Heating the steel above recrystallisation temp holding at that temp particular time period followed by cooling. Recrystallisation temp is not fixed it depends on chemical composition, amount of deformation in holding time and the internal grain size.
- Lower the degree of deformation or longer the holding time lowers the recrystallisation temp.
- Structural change:
- After this treatment property changes by cold working are removed.
- Ductility increase hardness and strength decrease. Structural change:

After this treatment property change by cold working are removed.

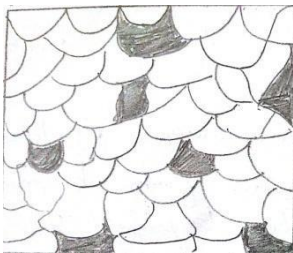

Before

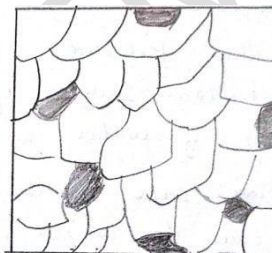

After

Application: manufacturing steel wires, sheets or strips.

3. Discuss the method of constructing isothermal diagrams. {APRIL/MAY 2011} Time-

Temperature-Transformation (TTT) Curve

- TTT diagram is a plot of temperature versus the logarithm of time for a steel alloy of definite composition. It is used to determine when transformations begin and end for an isothermal heat treatment of a previously **austenitized** alloy. TTT diagram indicates when a specific transformation starts and ends and it also shows what percentage of transformation of austenite at a particular temperature is achieved.

Time-Temperature-Transformation (TTT) Curve

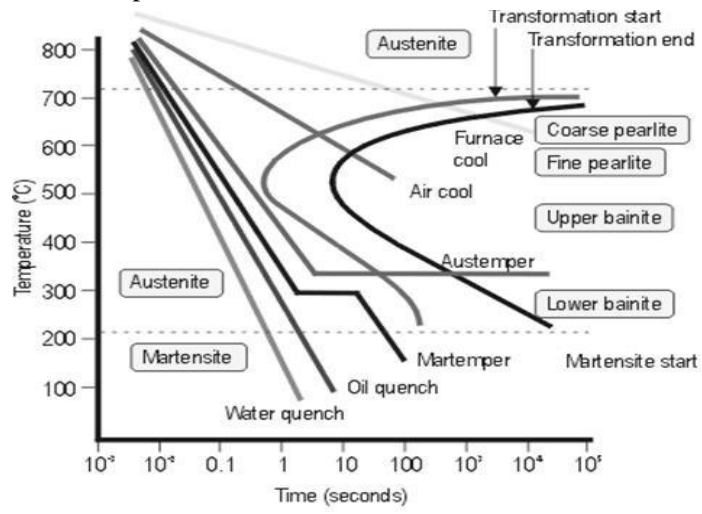

ME8491 EM SACET

The TTT diagram for AISI 1080 steel (0.79%C, 0.76%Mn) austenitised at 900°C

- **Isothermal transformation diagrams** (also known as time-temperature-transformation (TTT) diagrams) are plots of temperature versus time (usually on a logarithmic scale). They are generated from percentage transformation-vs logarithm of time measurements, and are useful for understanding the transformations of an alloy steel that is cooled isothermally. An isothermal transformation diagram is only valid for one specific composition of material, and only if the temperature is held constant during the transformation, and strictly with rapid cooling to that temperature. Though usually used to represent transformation kinetics for steels, they also can be used to describe the kinetics of crystallization in ceramic or other materials. Time-temperature-precipitation diagrams and time-temperature-embrittlement diagrams have also been used to represent kinetic changes in steels.

Isothermal transformation (IT)

- Diagram or the C-curve is associated with mechanical properties, micro constituents/microstructures, and heat treatments in carbon steels. Diffusional transformations like austenite transforming to a cementite and ferrite mixture can be explained using the sigmoidal curve; For example the beginning of pearlitic transformation is represented by the pearlite start (P_s) curve. This transformation is complete at P_f curve. Nucleation requires an incubation time. The rate of nucleation increases and the rate of micro constituent growth decreases as the temperature decreases from the liquidus temperature reaching a maximum at the bay or nose of the curve. Thereafter, the decrease in diffusion rate due to low temperature offsets the effect of increased driving force due to greater difference in free energy. As a result of the transformation, the microconstituents, Pearlite and Bainite, form; Pearlite forms at higher temperatures and bainite at lower.
- Austenite is slightly undercooled when quenched below Eutectoid temperature. When given more time, stable micro constituents can form: ferrite and cementite. Coarse pearlite is produced when atoms diffuse rapidly after phases that form pearlite nucleate. This transformation is complete at the pearlite finish time (P_f).
- However, greater undercooling by rapid quenching results in formation of martensite or bainite instead of pearlite. This is possible provided the cooling rate is such that the cooling curve intersects the martensite start temperature or the bainite start curve before intersecting the P_s curve. The martensite transformation being a diffusionless shear transformation is represented by a straight line to signify the martensite start temperature.

4. Explain the procedure of Jominy end quench test.(A/M 2009,2011,2013)

Hardenability:

The term hardenability refers to the ease with which hardness may be attained. That is the ease with which a steel will transform to hardened structure on quenching is called hardenability. The hardenability of a steel is defined as that property which determines the depth and distribution of hardness induced by quenching from the austenitic condition.

Factors affecting hardenability:

1. The composition of the steel
2. The austenitic grain size.
3. The structure of the steel before quenching
4. The quenching medium and the method of quenching

Determining hardenability (Jominy end quench test)

1. The most widely adopted method of determining hardenability is the Jominy end-quench test method.

2. The Jominy end-quench test method is universally adopted because:
- (i) It is relatively easy to perform
 - (ii) It is excellent reproducibility
 - (iii) It gives information useful to a designer as well as manufacturer.

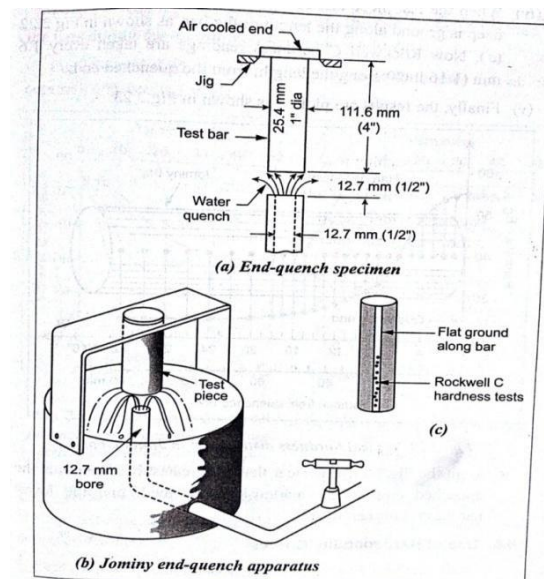

Testing procedure:

- In this test, specimen dimensions and test conditions are standard.
- Specimen is of cylindrical shape of diameter 25.4mm (1 inch) length of approximately 102mm (4 inch). It has a machined shoulder at one of its ends.
- Standard specimen is austenitized at a constant temperature for a fixed amount of time & quickly transferred to quenching jig fixture.
- Water is allowed to flow from the bottom end through a pipe of internal diameter 12.7mm for about 20 minutes.
- The distance between the bottom end of the specimen pipe is maintained as 12.7mm (1/2 inch)
- The pressure of water jet is adjusted such that the free height of water jet is 64mm (2.5 inch).
- At this pressure water forms a complete umbrella over the bottom surface of the specimen.
- Temp of water is required to maintain in between 21 to 27°C.
- Cooling rate of the specimen varies from bottom which is subjected to water quenching to the top end which is air cooled.
- The bottom end is subjected to full hardening when the top end undergoes normalizing cycle.
- Thus the specimen is subjected to all possible rates of cooling throughout its length.
- This cooling rate is independent of the composition of the specimen.

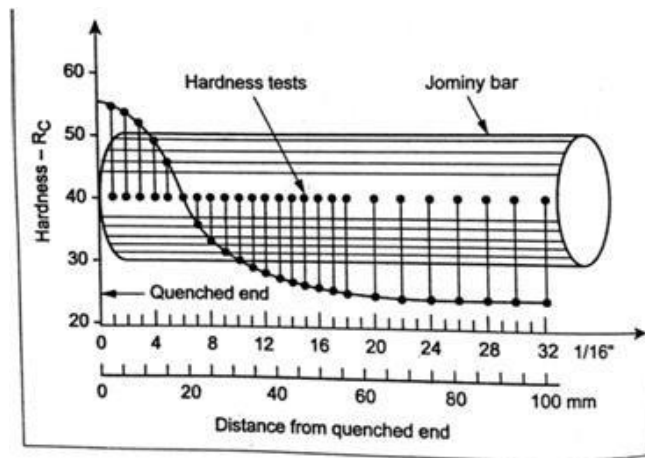

Typical hardness distribution in Jominy bars

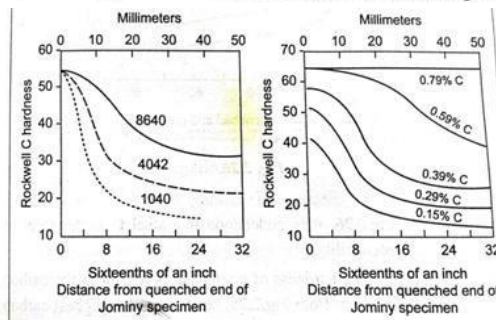

Jominy hardness curves for engineering steels with the same carbon content and varying types and amounts of alloy elements

Jominy hardness curves for engineering steels with identical alloy conditions but variable carbon content

Interrupted quenching:-

Continuous rapid cooling (quenching) at room temp use to form martensite has disadvantage of setting up severe internal stress warping of the material and crack form in steel less costlies to achieve desired hardness to reduces stress is an interrupted quenching process.

PART-C

1. Explain Case hardening

Classified as carburizing, nitriding, cyaniding, carbonitriding [N/D'15]

CARBURIZING:

- Introduce carbon into surface layer of low carbon steels in order to produce a hardsurface.
- Old and cheapest method
- Depth of case 0.5 to 2mm.
- Temp range 900-930oC.
- Solubility of carbon is more in austenite state than in ferrite state, fully austenitestate is required for carburizing.
- Achieved by heating steel above critical temp
- Diffusion of carbon is made by holding the heated steel in contact withcarbonaceous material which may be a solid a liquid or a gas.

Depend on carburizing medium, methods of carburizing

- (i) Pack carburizing
- (ii) Gas carburizing

(iii) Liquid carburizing

(i) Pack carburizing

- 900-950°C for 6 to 8 hours
- Cooled at room temperature
- Reactions takes place in the process

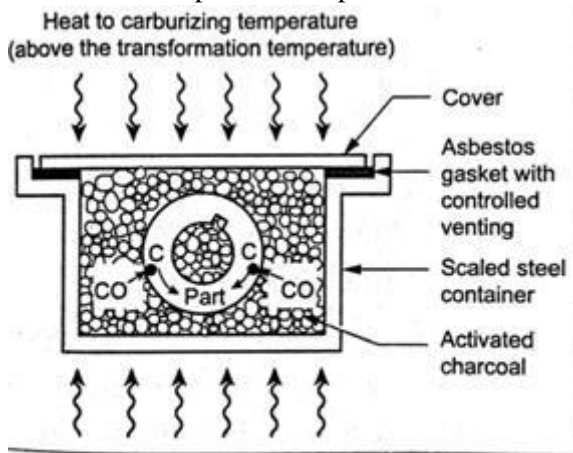

Pack carburising

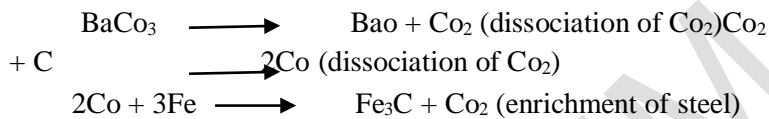

Advantage:

- Economic and efficient
- Suitable for massive parts

Disadvantages:

- Not suitable for thin carburized cases
- Does not provide close control or tolerance
- Increase time.

(ii) Gas carburizing:

- 900°C for 3 to 4 hours
- Heated in contact with hydrocarbon like methane, ethane or propane with carrier gases like N₂, H₂ & CO.



Advantages:

- Suitable for mass production
- Decrease Time for operation
- Low labor cost
- Low floor size.

(iii) Liquid carburizing:

- It carried out in molten baths, containing 20 to 50% sodium cyanide, 40% sodium carbonate and varying amounts of sodium or barium chloride.
- Mixture is melted with 815°C and 900°C in molten bath for 5 mins to 1 Hr. BaCl₂

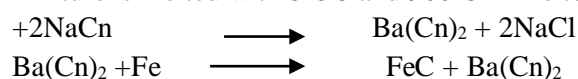

Advantages:

- Uniform heat transfer
- Decrease time
- Rapid rate of penetration

Disadvantages:

- Cyanic salts are highly poisonous.
- Parts should be thoroughly washed to avoid rasting

NITRIDING:

- Process of saturating the surface of steel with nitrogen.
 - Ammonia gas on the surface of steel at temp 480oC to 650oC.Process:
 - Before nitriding component s should be hafdenend , tempered , machiningoperation like grinding.
 - Only finishing grinding or lapping is done after nitriding.
 - Nitriding is suitable for medium carbon steels , alloy steels containg Al,Mo,Sbcantimony.
- $$2\text{NH}_3 + 3\text{H}_2 \longrightarrow 2\text{N} + 3\text{H}_2 \text{ (dissociation of ammonia)}$$
- After nitriding cooled to 200°C in a stream of ammonia.

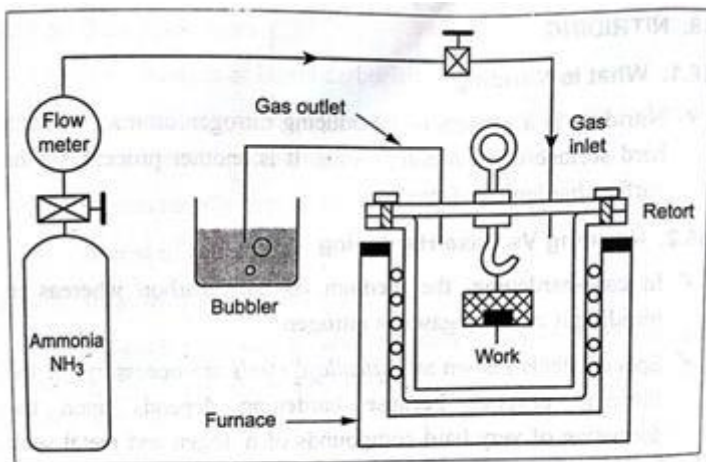

Schematic of a gas nitriding system

Advantages :

- Hardest cases of RC70 are obtained.
- Increase surface hardness
- Increase wear resistance to steel
- Fatigue limit and corrosion resistant.
- No quenching
- Hardening defects are avoided by nitriding.

Disadvantages:

- Increase more time for gas carburizing
- Two distinct zone
- Outer zone (white layer it should be hard and brittle)
- Inner zone (alloy nitride precipitation)
- Ammonia cost is high
- Technical control is required

Application :

- Aircraft engine parts such as cams, cylinder, valve stems, shafts, piston rods, crankpins & journals, aero crankshafts.

CYANIDING:

- Hardening process (surface of steel) is carbon and nitrogen.
- Depth is 0.1 to 0.2 mm.
- Cyanide compounds decompose release their cyan group.
- Cyan group contains carbon and nitrogen atoms, iron. $2\text{NaCN} + \text{Co}_2 \longrightarrow \text{Na}_2\text{CO}_3 + \text{Co} + 2\text{N}$
- $3\text{Fe} + 2\text{Co} \longrightarrow \text{Fe}_3\text{C} + \text{Co}_2\text{Fe}$
- $+ \text{N} \longrightarrow \text{FeN}$

Types of cyaniding:

- Pack cyaniding
- Liquid cyaniding
- Low temperature cyaniding
- Medium temperature cyaniding
- High temperature cyaniding

cyaniding :

- Powered mixture consists of charcoal and potassium ferro cyanide.
- 540 to 560 °C (1.5 to 3hrs)
- Used to improve cutting properties of steel

cyaniding :

- Molten bath in which various cyanide compounds NaCN , $\text{Ca}(\text{CN})_2$ are dissolved.

Advantages :

- Increase surface hardness
- Increase resistance and fatigue limit

Application :

- Suitable for gears, Pistons, Pins, small shafts etc.

CARBONITRIDING :

- In cyaniding the surfaces are enriched with carbon and nitrogen using liquid baths.
- Carbonitriding the surfaces are enriched with carbon and nitrogen using gaseous atmosphere.
- 850°C – 930°C (with gas mixture natural gas and ammonia)
- Process is lower than liquid cyaniding
- Nitrogen (steel surface) increase hardenability
- Permit 0:1 quench
- Hardness steel RC 65.
- Depth 0.5mm

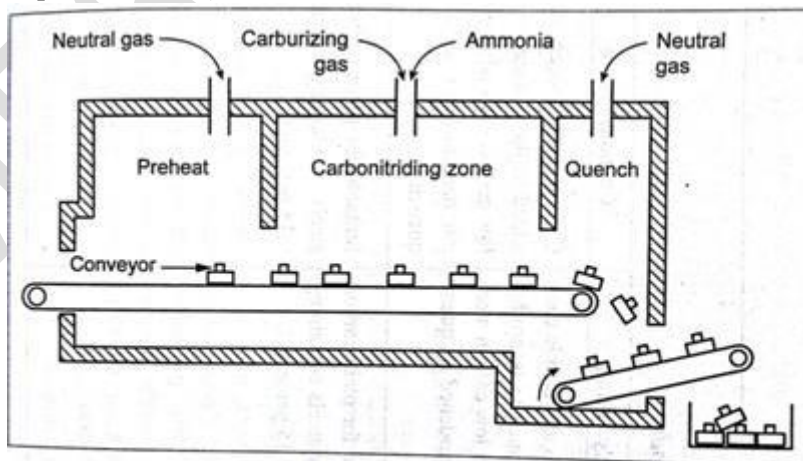

Conveyor hearth carbonitriding

2.Explain Vacuum Hardening and plasma Hardening

VACCUM HARDENING:

- Vacuum hardening heat treatment is carried out vacuum furnaces and it has many advantages.
- No decarburization
- No oxidation and hence bright surface
- Uniformity in temperature and hence low distortion.
- Temperature guided by defined thermocouple.
- Fully automation of heat treatment process.

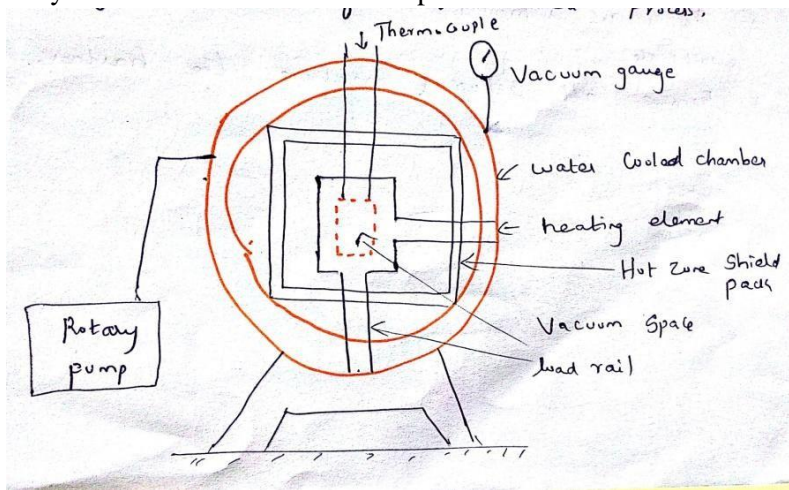

PLASMA HARDENING:

- It is hardening surface method
- Increase economical, effective and promising technology in heat treatment.
- Austenite structure martensite structure.
- No quenching medium
- Negative terminal connect to tungsten electrode.
- Positive terminal work piece.
- Maintain 13mm distance between nozzle and work piece.
- 30 amps current torch plasma arc is produced.
- After arc is moved over the entire surface of the work piece.
- Remove all setup and measure the hardeners values

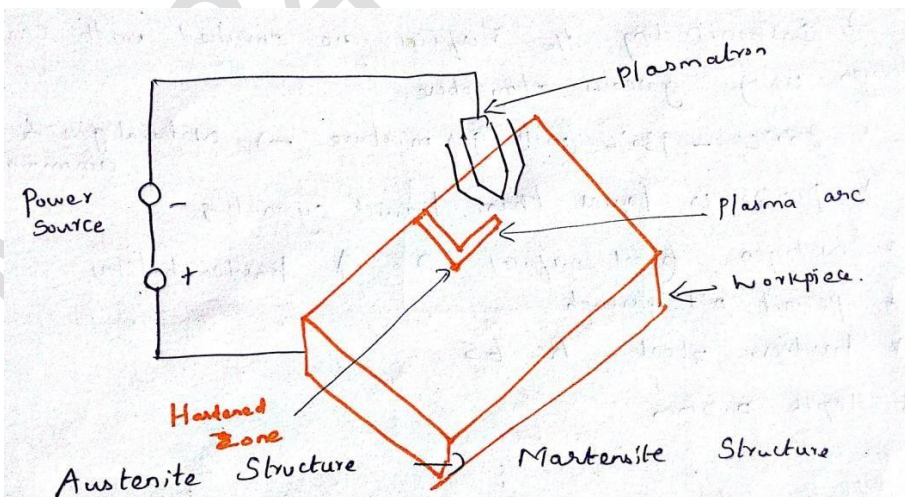

UNIT – 3: FERROUS AND NON-FERROUS METALS

PART: A

1. What are HSLA steels?[A/M'15]

HSLA steels are High- Strength Low – Alloy steels. HSLA steels are low carbon steels containing small amounts of alloying elements.

2. What are the required properties of tool steel?[N/D'16]

- Good toughness
- Good wear resistance
- Very good machinability

3. What are Gun metals?

Gun metals are alloys of Copper , Tin and Zinc.

4. What are the applications of plain carbon steels?

- Plain carbon steels are used for mass – production products such as automobiles and appliance.
- They also find applications in the production of ball bearings, base plates, housings, chutes, structural members, etc.

5. What are the applications of high carbon steels?

Typical applications of plain high-carbon steels include cutting tools and dies, knives, razors, hacksaw blades, springs, and high-strength wires, etc. these are the application of high carbon steels.

6. What are the types of aluminium alloys?

The alloys of aluminium may be subdivided into two groups as:

- Heat –treatable aluminum alloys, and
- Non-heat treatable aluminum alloys.

7. List two factors that affect hardenability of steels.

- composition of steel
- austenite grain size
- structure of steel before quenching
- the quenching medium and the method of quenching.

8. What are bronzes? List some use of bronzes.[N/D'16]

Bronzes are alloys of copper and any other major alloying element but not zinc. (eg – Al, Be, Sn, etc.)

Uses of bronzes: jewellery, condenser tubes, marine applications, cigarette cases, pump casting parts, etc.

9. What is the difference between white cast iron and gray cast iron ?

- i) In white cast iron all the carbon is present in the combined form i.e , cementite and there is no free carbon (graphite) because of which the fractured surface appears white, hence called white cast iron.
- ii) gray cast iron consist of graphite in the form of flakes and appear gray hence called gray cast iron.

10. What are the effect chromium and molybdenum in low alloy steel ?

The effects of alloying elements are follows:

- i) Chromium
 - It forms chromium carbides with increase hardenability. It increase wear resistance. It also increase corrosion and oxidation resistance.
- ii) Molybdenum
 - It increase hardenability. It forms carbide and increase wear resistance, reduce decarburization. it increase high temperature creep resistance.

11. What is bearing alloy? [N/D'15]

Materials which are used for making bearings are known as bearing materials. White metals, copper base alloys, aluminium base alloys are examples

PART: B

1) (i) Enumerate the composition and applications of following alloys. (1) Cupronickel [N/D'16]

(2) Bronze

(ii) State the effects of the following alloying elements in steel bearing alloy.

CUPRONICKEL

Cupronickel, any of an important group of alloys of copper and nickel; the alloy containing 25 percent nickel is used by many countries for coins.

Applications:

Cupronickel is used in:

- tubes for light-duty condensers, feedwater heaters and evaporators used in power stations and desalination plants
- pipes carrying seawater to fire mains, cooling water systems and ship sanitary systems
- sheathing for wooden piles
- underwater fencing
- cabled tubes for hydraulic and pneumatic lines
- fasteners, crankshafts, hulls and other marine hardware used in boats
- silver-coloured circulation coins

BRASS

Brass is an alloy of copper and zinc; the proportions of zinc and copper can be varied to create a range of brasses with varying properties. In comparison, bronze is principally an alloy of copper and tin.

Applications:

It was used to create more powerful and long-lasting weapons, tools, and farm implements. Craftworkers also used it to make intricate castings—objects made by pouring melted bronze into a mold.

EFFECTS OF ALLOYING ELEMENTS IN STEEL Alloying elements are added to effect changes in the properties of steels. The basis of this section is to cover some of the different alloying elements added to the basic system of iron and carbon, and what they do to change the properties or effectiveness of steel.

MANGANESE

Manganese slightly increases the strength of ferrite, and also increases the hardness penetration of steel in the quench by decreasing the critical quenching speed. This also makes the steel more stable in the quench. Steels with manganese can be quenched in oil rather than water, and therefore are less susceptible to cracking because of a reduction in the shock of quenching. Manganese is present in most commercially made steels.

CHROMIUM

As with manganese, chromium has a tendency to increase hardness penetration. This element has many interesting effects on steel. When 5 percent chromium or more is used in conjunction with manganese,

the critical quenching speed is reduced to the point that the steel becomes air hardening. Chromium can also increase the toughness of steel, as well as the wear resistance. Probably one of the most well known effects of chromium on steel is the tendency to resist staining and corrosion. Steels with 14 percent or more chromium are referred to as stainless steels. A more accurate term would be stain resistant. Stainless tool steels will in fact darken and rust, just not as readily as the nonstainless varieties. Steels with chromium also have higher critical temperatures in heat treatment.

SILICON

Silicon is used as a deoxidizer in the manufacture of steel. It slightly increases the strength of ferrite, and when used in conjunction with other alloys can help increase the toughness and hardness penetration of steel.

NICKEL

Nickel increases the strength of ferrite, therefore increasing the strength of the steel. It is used in low alloy steels to increase toughness and hardenability. Nickel also tends to help reduce distortion and cracking during the quenching phase of heat treatment.

MOLYBDENUM

Molybdenum increases the hardness penetration of steel, slows the critical quenching speed, and increases high temperature tensile strength.

VANADIUM

Vanadium helps control grain growth during heat treatment. By inhibiting grain growth it helps increase the toughness and strength of the steel.

TUNGSTEN

Used in small amounts, tungsten combines with the free carbides in steel during heat treatment, to produce high wear resistance with little or no loss of toughness. High amounts combined with chromium gives steel a property known as red hardness. This means that the steel will not lose its working hardness at high temperatures. An example of this would be tools designed to cut hard materials at high speeds, where the friction between the tool and the material would generate high temperatures.

COPPER

The addition of copper in amounts of 0.2 to 0.5 percent primarily improves steels resistance to atmospheric corrosion. It should be noted that with respect to knife steels, copper has a detrimental effect to surface quality and to hot-working behavior due to migration into the grain boundaries of the steel.

Bearing alloy:

The widely bearing materials are

1. White metals
2. Copper base alloy
3. Aluminium base alloys
4. Plastic materials and
5. Ceramics

The selection of a particular bearing material depends upon types of loading running speed and service conditions.

State the effects of following alloying elements:

- (i) Chromium:
- Typical ranges in alloy steel 0.3-4
 - Increases corrosion and oxidation resistance.
 - Increases hardenability.
 - Increase high temperature strength.
 - Resists abrasion and wear.
- (ii) Molybdenum:
- Typical ranges in alloy steel 0.1-0.5
 - Improves high temperature creep resistance.
 - Reduces temper brittleness in Ni-Cr steels.
 - Stabilizes carbides.
 - Increases hardenability.

State objectives:

1. The properties of all steels are determined by the kind and amounts of phases of which they are composed by the properties of the phases and by the way in which these phases are distributed among one another.
2. Steel consists of two or more phases known as ferrite austenite carbides and graphite.

2. Write short notes on: [A/M'15]

(i) High speed steel

(ii) HSLA steel

(iii) Maraging steel

(iv) Tool steel

High speed steel:

- First produced in 1900s. They are highly alloyed with vanadium, cobalt, molybdenum, tungsten and chromium added to increase hot hardness and wearresistance.
- Can be hardened to various depths by appropriate heat treating up to coldhardness in the range of HRC 63-65.
- The cobalt component gives the material a hot hardness value much greater than carbon steels.
- The high toughness and good wear resistance make HSS suitable for all type of cutting tools with complex shapes for relatively low to medium cutting speeds.
- The most widely used tool material today for taps, drills, reamers, gear tools, endcutters, slitting, broaches, etc.

HSLA steel:

- High-strength low-alloy steel (HSLA) is a type of alloy steel that provides better mechanical properties or greater resistance to corrosion than carbon steel.
- HSLA steels vary from other steels in that they are not made to meet a specific chemical composition but rather to specific mechanical properties. They have a carbon content between 0.05–0.25% to retain formability and weldability.
- Other alloying elements include up to 2.0% manganese and small quantities of copper, nickel, niobium, nitrogen, vanadium, chromium, molybdenum, titanium, calcium, rare earth elements, or zirconium. Copper, titanium, vanadium, and niobium are added for strengthening purposes.
- These elements are intended to alter the microstructure of carbon steels, which is usually a ferrite-pearlite aggregate, to produce a very fine dispersion of alloy carbides in an almost pure

ferrite matrix.

- This eliminates the toughness-reducing effect of a pearlitic volume fraction yet maintains and increases the material's strength by refining the grain size, which in the case of ferrite increases yield strength by 50% for every halving of the mean grain diameter. Precipitation strengthening plays a minor role, too.
- Their yield strengths can be anywhere between 250–590 megapascals (36,000– 86,000 psi). Because of their higher strength and toughness HSLA steels usually require 25 to 30% more power to form, as compared to carbon steels.

Maraging steel:

- Maraging steels (a portmanteau of "martensitic" and "aging") are steels (iron alloys) that are known for possessing superior strength and toughness without losing malleability, although they cannot hold a good cutting edge.
- *Aging* refers to the extended heat-treatment process. These steels are a special class of low-carbon ultra-high-strength steels that derive their strength not from carbon, but from precipitation of intermetallic compounds.
- The principal alloying element is 15 to 25 wt.% nickel. Secondary alloying elements, which include cobalt, molybdenum, and titanium, are added to produce intermetallic precipitates. Original development (by Bieber of Inco in the late 1950s) was carried out on 20 and 25 wt.% Ni steels to which small additions of Al, Ti, and Nb were made; a rise in the price of cobalt in the late 1970s led to the development of cobalt-free maraging steels.
- The common, non-stainless grades contain 17–19 wt.% nickel, 8–12 wt.% cobalt, 3–5 wt.% molybdenum, and 0.2–1.6 wt.% titanium. Addition of chromium produces stainless grades resistant to corrosion.
- This also indirectly increases hardenability as they require less nickel: high-chromium, high-nickel steels are generally austenitic and unable to transform to martensite when heat treated, while lower-nickel steels can transform to martensite.

Tool steel:

- Tool steel refers to a variety of carbon and alloy steels that are particularly well-suited to be made into tools.
- Their suitability comes from their distinctive hardness, resistance to abrasion and deformation and their ability to hold a cutting edge at elevated temperatures. As a result tool steels are suited for their use in the shaping of other materials.
- With carbon content between 0.5% and 1.5%, tool steels are manufactured under carefully controlled conditions to produce the required quality.
- The presence of carbides in their matrix plays the dominant role in the qualities of tool steel. The four major alloying elements in tool steel that form carbides are: tungsten, chromium, vanadium and molybdenum.
- The rate of dissolution of the different carbides into the austenite form of the iron determines the high temperature performance of steel (slower is better, making for a heat resistant steel).
- Proper heat treatment of these steels is important for adequate performance. The manganese content is often kept low to minimize the possibility of cracking during water quenching.
- There are six groups of tool steels: water-hardening, cold-work, shock-resisting, high-speed, hot-work, and special purpose.
- The choice of group to select depends on, cost, working temperature, required surface hardness, strength, shock resistance, and toughness requirements. The more severe the service condition

(higher temperature, abrasiveness, corrosiveness, loading), the higher the alloy content and consequent amount of carbides required for the tool steel.

- C26800, Yellow brass, is the single phase alpha brass with the lowest content of copper. It is used where its deep drawing properties and lower cost give an advantage. When welded, particles of beta phase may form, reducing ductility and corrosion resistance.

3.) Discuss different types of copper alloys and their properties and applications.

Copper and copper alloys are some of the most versatile engineering materials available. The combination of physical properties such as strength, conductivity, corrosion resistance, machinability and ductility make copper suitable for a wide range of applications. These properties can be further enhanced with variations in composition and manufacturing methods.

Copper is the oldest metal used by man, its use dates back to prehistoric times. Copper has been mined for more than 10,000 years with a copper pendant found in current day Iraq being dated to 8700BC.

Copper is found as native metal and in the minerals cuprite, malachite, azurite, chalcopyrite and bornite. It is also often a by-product of silver production. Sulfides, oxides and carbonates are the most important ores.

Copper and copper alloys are some of the most versatile engineering materials available. The combination of physical properties such as strength, conductivity, corrosion resistance, machinability and ductility make copper suitable for a wide range of applications. These properties can be further enhanced with variations in composition and manufacturing methods.

APPLICATIONS OF COPPER

Copper and copper alloys can be used in an extraordinary range of applications. Some of these applications include:

- Power transmission lines
- Architectural applications
- Cooking utensils
- Spark plugs
- Electrical wiring, cables and busbars
- High conductivity wires
- Electrodes
- Heat exchangers and refrigeration tubing
- Plumbing
- Water-cooled copper crucibles.

The largest end use for copper is in the building industry. Within the building industry the use of copper-based materials is broad. Construction industry related applications for copper include:

- Roofing
- Cladding
- Rainwater systems
- Heating systems
- Water pipes and fittings
- Oil and gas lines
- Electrical wiring.

TYPES OF COPPER ALLOYS

Commercially pure coppers are very soft and ductile, containing up to about 0.7% total impurities.

These materials are used for their electrical and thermal conductivity, corrosion resistance, appearance and color, and ease of working. They have the highest conductivity of the engineering metals and are very ductile and easy to braze, and generally to weld. Typical applications include electrical wiring and fittings, busbars, heat exchangers, roofs, wall cladding, tubes for water, air and process equipment.

High copper alloys contain small amounts of various alloying elements such as beryllium, chromium, zirconium, tin, silver, sulphur or iron. These elements modify one or more of the basic properties of copper, such as strength, creep resistance, machinability or weldability. Most of the uses are similar to those given above for coppers, but the conditions of application are more extreme.

Brasses are copper zinc alloys containing up to about 45% zinc, with possibly small additions of lead for machinability, and tin for strength. Copper zinc alloys are single phase up to about 37% zinc in the wrought condition. The single phase alloys have excellent ductility, and are often used in the cold worked condition for better strength. Alloys with more than about 37% zinc are dual phase, and have even higher strength, but limited ductility at room temperature compared to the single phase alloys. The dual phase brasses are usually cast or hot worked.

Typical uses for brasses are architecture, drawn & spun containers and components, radiator cores and tanks, electrical terminals, plugs and lamp fittings, locks, door handles, name plates, plumbers hardware, fasteners, cartridge cases, cylinder liners for pumps.

Brasses are divided into two classes. These are:

- The alpha alloys, with less than 37% Zinc. These alloys are ductile and can be coldworked.
- The alpha/beta or duplex alloys with 37-45% Zinc. These alloys have limited cold ductility and are typically harder and stronger.

There are three main families of wrought alloy brasses:

- Copper-Zinc alloys
- Copper-Zinc-Lead alloys (Leaded brasses)
- Copper-Zinc-Tin alloys (Tin brasses)

Cast brass alloys can be broken into four main families:

- Copper-Tin-Zinc alloys (red, semi-red and yellow brasses)
- Manganese Bronze alloys (high strength yellow brasses) and Lead Manganese Bronze alloys (leaded high strength yellow brasses)
- Copper-Zinc-Silicon alloys (Silicon brasses and bronzes)
- Cast Copper-Bismuth and Copper-Bismuth-Selenium alloys.

Bronzes are alloys of copper with tin, plus at least one of phosphorus, aluminum, silicon, manganese and nickel. These alloys can achieve high strengths, combined with good corrosion resistance. They are used for springs and fixtures, metal forming dies, bearings, bushes, terminals, contacts and connectors, architectural fittings and features. The use of cast bronze for statuary is well known.

Copper nickel are alloys of copper with nickel, with a small amount of iron and sometimes other minor alloying additions such as chromium or tin. The alloys have outstanding corrosion resistance in waters, and are used extensively in sea water applications such as heat exchangers, condensers, pumps and piping systems, sheathing for boat hulls.

Nickel silvers contain 55–65% copper alloyed with nickel and zinc, and sometimes an addition of lead to promote machinability. These alloys get their misleading name from their appearance, which is similar to pure silver, although they contain no addition of silver. They are used for jewelry and name plates and as a base for silver plate (EPNS), as springs, fasteners, coins, keys and camera parts.

PROPERTIES OF COPPER ALLOYS

Corrosion Resistance of Copper. All copper alloys resist corrosion by fresh water and steam. In most rural, marine and industrial atmospheres copper alloys are also resistant to corrosion. Copper is resistant to saline solutions, soils, non-oxidizing minerals, organic acids and caustic solutions. Moist ammonia, halogens,

sulfides, solutions containing ammonia ions and oxidizing acids, like nitric acid, will attack copper. Copper alloys also have poor resistance to inorganic acids. The corrosion resistance of copper alloys comes from the formation of adherent films on the material surface. These films are relatively impervious to corrosion therefore protecting the base metal from further attack.

4. With part of phase diagram and relevant sketches, explain the precipitation hardening treatment of Al-Cu alloys. [M/J'16]

PRECIPITATION STRENGTHENING TREATMENT:

In designing alloys for strength an approach after taken is to develop an alloy with a structure that consists of particles dispersed in a ductile matrix. Such a dispersion can be obtained by choosing an alloy that is single phase at elevated temperatures but on cooling will precipitate another phase in the matrix, when alloy is strengthened by this thermal treatment, it is called precipitation strengthening or hardening.

Precipitation strengthening consists of three main steps.

1. Solution treatment
2. Quenching
3. Aging

SOLUTION HEAT TREATMENT:

To take advantage of precipitation hardening reaction, it is necessary first to produce a solid solution. The process by which this is accomplished is called solution heat treating and its objective is to take into solid solution the maximum practical amounts of soluble hardening elements in the alloy. The processes consist of soaking the alloy at a temperature sufficiently high and for time long enough to achieve a nearly homogenous solid solution.

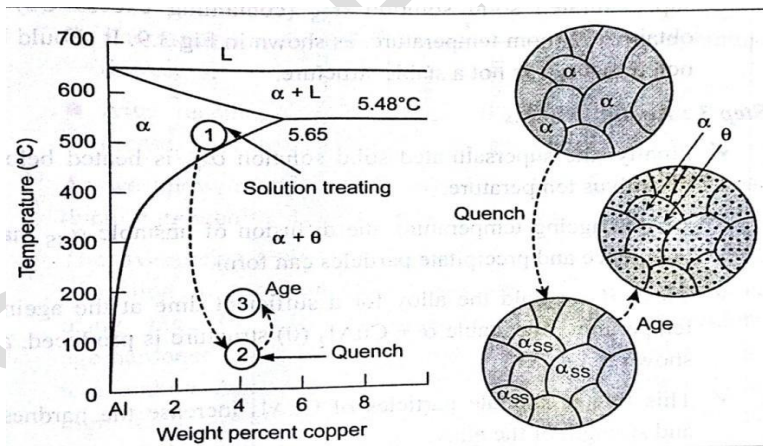

QUENCHING:

Quenching is in many ways the most critical step in the sequence of heat treating operations. The objective of quenching is to preserve the solid solution formed at the solution heat treating temperature by rapidly cooling to some lower temperature usually near room temperature.

In most cases, the solid solution formed during solution heat treatment must be quenched rapidly enough to produce the supersaturated solution at room temperature the optimum condition for precipitation hardening. Quenching rapidly cools the solution and frees the atoms in solution. In more technical terms, the quenching cools the material so fast that the atoms of the alloying elements do not have time to diffuse out of the solution. Most frequently parts are quenched by immersion in cold water or in continuous heat treating of sheet plate or extrusions in primary fabricating mills by progressive flooding or

high velocity spraying with water.

AGING OR AGE HARDENING:

Aging is the process where the solute particles diffuse out of solution and into clusters that distort and strengthen the material. After solution and quenching, hardening is achieved either at room temperature or with a precipitation heat treatment. In some alloys, sufficient precipitation occurs in a few days at room temperature to yield stable products with properties that are adequate for many applications.

These alloys sometimes are precipitation heat treated to provide increased strength and hardness in wrought or cast products other alloys with and hardness reaction at room temperature are always precipitation heat treated before use precipitation heat treatments generally are low temperature, long term processes and temperatures range from 115°C to 190°C times vary from 5 to 48 hours. The precipitation hardening process for a copper aluminium alloy is shown graphically on the right is a phase diagram which is very useful tool for understanding and controlling polyphase structures. The phase present as the temperature and over all composition of the alloy are varied.

PART-C

1. Write short notes on:

(i) Austenitic stainless steel (5)

(ii) Ferritic stainless steel (5)

(iii) Martensitic stainless steel (6)

(i) Austenitic Stainless Steel:

- Austenitic stainless steels are a class of alloys with a face-centered-cubic lattice structure of austenite over the whole temperature range from room temperature (and below) to the melting point.
- In ferritic steels there is a transformation from the body-centered-cubic lattice structure of ferrite to the face-centered-cubic lattice structure of austenite.
- The temperature of this transformation depends upon the composition but is about 1340° F for a plain-carbon steel similar to the SA178 or SA210 grades.
- When 18% chromium and 8% nickel are added, the crystal structure of austenite remains stable over all temperatures.
- The nickel-based alloys with 35-70% nickel and 20-30% chromium, while not strictly steels (a steel must have at least 50% iron), do have the face-centered-cubic lattice arrangement and are also called austenitic materials.

(ii) Ferritic stainless steel:

- Ferritic stainless steels have a "body-centred-cubic" (bcc) crystal structure, which is the same as pure iron at room temperature.
- These steels contain less than 0.10% carbon and are magnetic. The fact that they can't be hardened via heat treatment and don't weld to a high standard limits the use of these metals somewhat, but they are still suitable for a wide range of applications.
- The main alloying element is chromium, with contents typically between 11 and 17%, although higher a chromium content of about 29% is found in one specialised grade.
- Carbon is kept low which results in these steels having limited strength. They are not hardenable by heat treatment and have annealed yield strengths in the range of 275 to 350 MPa.

(iii) Martensitic stainless steel:

- Martensitic stainless steels are similar to low alloy or carbon steels. They have a structure similar to the ferritics with a 'body-centred tetragonal' (bct) crystal lattice.
- Due to the addition of carbon, they can be hardened and strengthened by heat treatment, in a similar way to carbon steels. They are classed as a "hard" ferro- magnetic group.
- The main alloying element is chromium, with a typical content of 12-15%. In the annealed condition, they have tensile yield strengths of about 275 MPa and so they are usually machined, cold formed, or cold worked in this condition.
- The strength obtained by heat treatment depends on the carbon content of the alloy. Increasing the carbon content increases the strength and hardness potential but decreases ductility and toughness.
- The higher carbon grades are capable of being heat treated to hardnesses of 60 HRC. Optimum corrosion resistance is attained in the heat-treated i.e. hardened and tempered condition.
- Martensitic grades have been developed with nitrogen and nickel additions but with lower carbon levels than the traditional grades. These steels have improved toughness, weldability and corrosion resistance

2) What are the types of titanium alloy, their composition properties and applications?

[N/D'15]

Titanium and its alloys are new engineering materials that possess an extraordinary combination of mechanical properties. Titanium alloys are extremely strong, room temperature tensile strengths as high as 14000MPa are attainable yielding remarkable specific strengths, highly ductile, easily forged and machined.

ALLOY NAME & COMPOSITION	MECHANICAL PROPERTIES	APPLICATIONS
Commercially Pure-99.1%Ti	Tensile strength (MPa)-484 Yield strength (MPa)-414 Ductility (% elongation in 50mm)-25	Jet engine shrouds, cases and airframe skins, corrosion resistant equipment for marine and chemical processing industries
Alpha alloy 5% Al, 2.5% Sn, balance Ti	Tensile strength (MPa)-826 Yield strength (MPa)-784 Ductility (% elongation in 50mm)-16	Gas turbine engine casings and rings, chemical processing equipment requiring strength to temperatures of 480 degree Celsius
Near alpha alloy 8% Al, 1% Mo, 1% V, balance Ti	Tensile strength (MPa)-950 Yield strength (MPa)-890 Ductility (% elongation in 50mm)-15	Forgings for jet engine components (compressor disks, plates and hubs)
Alpha Beta alloy 6% Al, 4% V, balance Ti	Tensile strength (MPa)-947 Yield strength (MPa)-877 Ductility (% elongation in 50 mm)-14	High strength prosthetic implants, chemical processing equipment, airframe structural components.

Alpha Beta alloy 6% Al, 2% Sn, 6% V, 0.75% Cu, balance Ti	Tensile strength (MPa)-1050 Yield strength (MPa)-985 Ductility (% elongation in 50 mm)-14	Rocket engine case airframe applications and high strength airframe structures
Alpha alloy 10% V, 2% Fe, 3% Al, balance Ti	Tensile strength (MPa)-1223 Yield strength (MPa)-1150 Ductility (% elongation in 50 mm)-10	Aircraft tailpipe assemblies, missile fuel tanks and structural parts operating for short times upto 593 degree Celsius.

ME8491 EM SACET

UNIT- 4: NON-METALLIC MATERIALS

PART: A

1. Define FRP

FIBER – reinforced plastic or fiber – reinforced polymer is a composite material made of a polymer matrix reinforced with fiber.

Generally, the fibers are fiber glasses, carbon or aramid whereas the polymer is an epoxyvinylester or polyester thermosetting plastics.

FRP are widely used in aerospace, automotive, marine and construction field.

2. Give few important characteristics of polymer.

- i) Polymers are light in weight
- ii) They have high corrosion resistance
- iii) Low density
- iv) Low thermal and electrical properties.
- v) Easy to fabricate
- vi) Low cost.

3. What is hybrid composite?

- Hybrid composites are those composites which have a combination of two or more reinforced fibers.
- The most common hybrid composites are carbon- aramid reinforced epoxy (which combines strength and impact resistance) and glass- carbon reinforced epoxy (which gives a strong material at reasonable prices)
- Hybrid composites are usually when a combination of properties of different types of fibers wants to be achieved, or when a longitudinal as well as lateral mechanical performance is required.

4. How are refractories classified?

- Fire clay refractories
- Silica refractories
- Basic refractories
- Special refractories

4. Define the term Degree of Polymerization? [N/D'16]

Degree of Polymerization is the number of repetitive units present in one molecule of a polymer.

5. What are PEEK and PMMA? [N/D'15]

PEEK is a Linear crystalline Hetero chain Polymer. It is a High temperature Plastic, which is generally used for service of High temperatures.

PMMA also commonly known as Perspex is Produced by the addition Polymerization of Methyl Methacrylate.

6. Name any four Commodity plastics and Engineering plastics?

Commodity plastic	Engineering plastics
<ul style="list-style-type: none">• Polyethylene• Polypropylene• Polystyrene• Polyvinyl Chloride	<ul style="list-style-type: none">• Ethene• Polyamides• Cellulosics• Acetals

7. Distinguish between Thermo Plastics and Thermosetting Plastics? [A/M'15]

S.No	Thermo Plastics	Thermosetting Plastics
1	They are formed by addition Polymerization	They are formed by Condensation Polymerization
2	They can be Recycled again	They cannot be Recycled again

8. What are engineering ceramics? [M/J'16]

Engineering ceramics, are also known as technical/ industrial ceramics or advanced ceramics, are those ceramics that are specially used for engineering application or in industries. It is mainly oxides, carbides, sulphides, and nitrides of metals.

9. What are the three stages in addition polymerization?

The addition polymerization occurs in three stages:

- Initiation,
- Propagation, and
- Termination

10. What is polymerisation? [M/J'16]

It is a process of forming a polymer by linking together of monomers.

11. State the advantages of fibre reinforced composites. [M/J'16]

- Low relative density
- Good resistance to corrosion
- Good fatigue resistance
- Low coefficient of thermal expansion.

PART: B

1. Describe the molecular structure, properties and application of the following polymers.
[A/M'15]

(i) Polyvinyl chloride (PVC) (4)

(ii) Polystyrene (PS) (4)

(iii) Polyethylene terephthalate (PET) (4)

(iv) Poly carbonate (4)

Polyvinyl chloride:

Poly(vinyl chloride) (PVC) has a chemistry and a physical structure that makes it broadly unique in the polymer world. PVC (often referred to vinyls or vinyl resins) is made commercially at several molecular weights, depending on the intended applications: from $M_w = 39000$ g/mol, to $M_w = 168000$ g/mol. PVC chemistry follows:

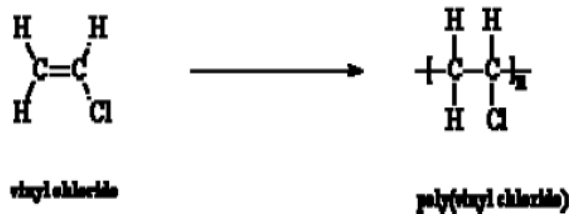

where n , i.e. degree of polymerization, ranges commercially from 625 to 2700. PVC has grown to be one of the major plastics of the world. It was the largest group of thermoplastic materials; however, the vinyl resins have been suppressed in volume by the olefin polymers. PVC is second in volume to polypropylene among plastic materials. The volume of each individual categories of polyethylene is smaller than PVC's.

Polystyrene:

Polystyrene (PS) is a synthetic aromatic polymer made from the monomer styrene. Polystyrene can be solid or foamed. General purpose polystyrene is clear, hard, and rather brittle. It is an inexpensive resin per unit weight. It is a rather poor barrier to oxygen and water vapor and has a relatively low melting point. Polystyrene is one of the most widely used plastics, the scale of its production being several billion kilograms per year. Polystyrene can be naturally transparent, but can be colored with colorants. Uses include protective packaging, containers (such as "clamshells"), lids, bottles, trays, tumblers, and disposable cutlery.

Properties:

- Flow properties may be the most important properties of polystyrene processes. There are two widely accepted industry methods for the measurement of processing properties.
- These include the melt flow index and the solution viscosity. The melt flow index is measured by ASTM method as a measure of the melt viscosity at 200°C and a 5kg load.
- Polystyrenes are commercially produced with melt flow ranges of less than 1 to greater than 50, although the most widely available grades generally have melt flows between 2.0 and 20g per 10min.
- Solution viscosity is another method for measuring the molecular structure of the polystyrene. Solution viscosity can be measured as an 8% solution in toluene and increases with increasing molecular weight.

- Crystal polystyrenes have very low impact strengths of less than 0.5ft-lb. Commercially available impact polystyrene grades can be obtained with values of 1.0 - 4.0 ft-lb. Generally, polystyrenes are not produced with greater than 15% total rubber because of polymerization processing constraints
- The glass transition temperature for unmodified polystyrene is 373 K, and the glass transition temperatures for polybutadienes are 161-205 K, subject to the cis, trans, and vinyl content.

Polyethylene terephthalate:

PET is an acronym for polyethylene terephthalate, which is a long-chain polymer belonging to the generic family of polyesters. PET is formed from the intermediates, terephthalic acid (TPA) and ethylene glycol (EG), which are both derived from oil feedstock. There are other polyesters based on different intermediates but all are formed by a polymerisation reaction between an acid and an alcohol. PET, in its purest form, is an amorphous glass-like material. Under the influence of direct modifying additives it develops crystallinity. Also, crystallinity can be developed by heat treatment of the polymer melt.

The three major packaging applications of PET are as containers (bottles, jars and tubs), semi-rigid sheet for thermoforming (trays and blisters) and thin oriented films (bags and snack food wrappers).

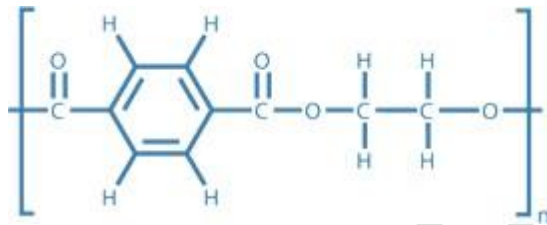

Poly carbonate:

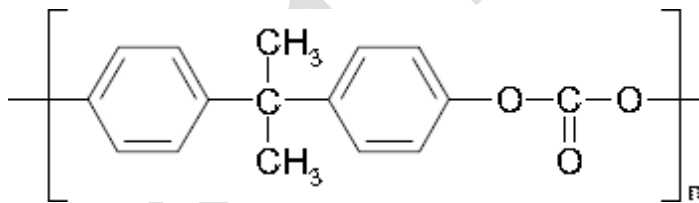

Polycarbonate is a durable material. Although it has high impact-resistance, it has low scratch-resistance. Therefore, a hard coating is applied to polycarbonate eyewear lenses and polycarbonate exterior automotive components. The characteristics of polycarbonate compare to those of polymethyl methacrylate (PMMA, acrylic), but polycarbonate is stronger and will hold up longer to extreme temperature. Polycarbonate is highly transparent to visible light, with better light transmission than many kinds of glass.

Polycarbonate has a glass transition temperature of about 147 °C (297 °F), so it softens gradually above this point and flows above about 155 °C (311 °F). Tools must be held at high temperatures, generally above 80 °C (176 °F) to make strain-free and stress-free products. Low molecular mass grades are easier to mold than higher grades, but their strength is lower as a result. The toughest grades have the highest molecular mass, but are much more difficult to process.

2. Describe the molecular structure, properties and application of the following polymeric materials. [N/D'15]

- (i) Poly methyl methacrylate (PMMA) (4)
- (ii) Poly tetra fluoro ethylene (PTFE) (4)
- (iii) Polyethylene terephthalate (PET) (4)
- (iv) Acryl nitride butadiene styrene. (4)

Poly methyl methacrylate:

General Poly(methacrylates) are polymers of the esters of methacrylic acids. The most commonly used among them is poly(methyl methacrylate) (PMMA).

Poly(methyl methacrylate) or poly (methyl 2-methylpropenoate) is the polymer of methyl methacrylate, with chemical formula $C_5H_8O_2)_n$. It is a clear, colourless polymer available on the market in both pellet and sheet form under the names Plexiglas, Acrylite, Perspex, Plazcryn, Acrylplast, Altuglas, Lucite etc. It is commonly called acrylic glass or simply acrylic.

Another polymer, poly(methyl acrylate) (PMA) is a rubbery material, similar to poly(methyl methacrylate), but softer than it, because its long polymer chains are thinner and smoother and can more easily slide past each other.

Poly(methyl methacrylate) is produced by free-radical polymerization of methylmethacrylate in mass (when it is in sheet form) or suspension polymerization according to the following chart:

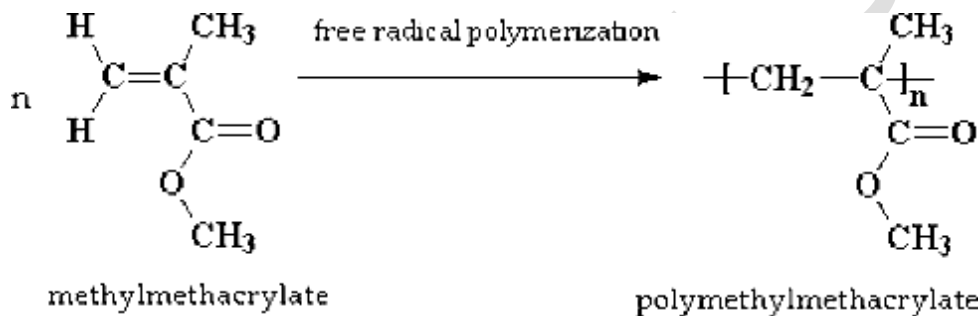

PMMA is a linear thermoplastic polymer. PMA has a lack of methyl groups on the backbone carbon chain - its long polymer chains are thinner and smoother and can slide past each other more easily, so the material becomes softer.

PMMA has high mechanical strength, high Young's modulus and low elongation at break. It does not shatter on rupture. It is one of the hardest thermoplastics and is also highly scratch resistant. It exhibits low moisture and water absorbing capacity, due to which products made have good dimensional stability. Both of these characteristics increase as the temperature rises.

Application:

- **Optics:** Dust covers for hi-fi equipment, sunglasses, watch glasses, lenses, magnifying glasses;
- **Vehicles:** Rear lights, indicators, tachometer covers, warning triangles;
- **Electrical engineering:** Lamp covers, switch parts, dials, control buttons;
- **Office equipment:** Writing and drawing instruments, pens;
- **Medicine:** Packaging for tablets, pills, capsules, suppositories, urine containers, sterilisable equipment;
- **Others:** Leaflet dispensers, shatter-resistant glazing, shower cubicles, transparent pipelines, illuminated signs, toys.

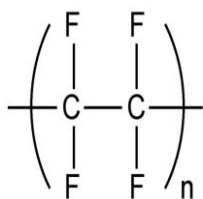

Poly tetra fluoro ethylene:

Poly tetra fluoro ethylene (PTFE) is a synthetic fluoro polymer of tetra fluoro ethylene that has numerous applications. The best known brand name of PTFE-based formulas is Teflon by DuPont Co., which discovered the compound.

PTFE is a fluorocarbon solid, as it is a high-molecular-weight compound consisting wholly of carbon and fluorine. PTFE is hydrophobic: neither water nor water-containing substances wet PTFE, as fluorocarbons demonstrate mitigated London dispersion forces due to the high electronegativity of fluorine. PTFE has one of the lowest coefficients of friction against any solid.

PTFE is used as a non-stick coating for pans and other cookware. It is very non-reactive, partly because of the strength of carbon-fluorine bonds and so it is often used in containers and pipework for reactive and corrosive chemicals. Where used as a lubricant, PTFE reduces friction, wear and energy consumption of machinery. It is also commonly used as a graft material in surgical interventions.

Properties:

- PTFE is a thermoplastic polymer, which is a white solid at room temperature, with a density of about 2200 kg/m³.
- According to DuPont, its melting point is 600 K (327 °C; 620 °F). It maintains high strength, toughness and self-lubrication at low temperatures down to 5 K (-268.15 °C; -450.67 °F), and good flexibility at temperatures above 194 K (-79 °C; -110 °F).
- PTFE gains its properties from the aggregate effect of carbon-fluorine bonds, as do all fluorocarbons. The only chemicals known to affect these carbon-fluorine bonds are reactive metals like alkali metals and at higher temperature also e.g. aluminium and magnesium and fluorinating agents such as xenon difluoride and cobalt(III) fluoride.

Applications:

- The major application of PTFE, consuming about 50% of production, is for wiring in aerospace and computer applications (e.g. hookup wire, coaxial cables). This application exploits the fact that PTFE has excellent dielectric properties.
- This is especially true at high radio frequencies, making it suitable for use as an insulator in cables and connector assemblies and as a material for printed circuit boards used at microwave frequencies.
- Combined with its high melting temperature, this makes it the material of choice as a high-performance substitute for the weaker and lower-melting-point polyethylene commonly used in low-cost applications.
- In industrial applications, owing to its low friction, PTFE is used for applications where sliding action of parts is needed: plain bearings, gears, slide plates, etc. In these applications, it performs significantly better than nylon and acetal; it is comparable to ultra-high-molecular-weight polyethylene (UHMWPE).
- Although UHMWPE is more resistant to wear than PTFE, for these applications, versions of PTFE with mineral oil or molybdenum disulfide embedded as additional lubricants in its matrix are being manufactured. Its extremely high bulk resistivity makes it an ideal material for fabricating long-life electrets, useful devices that are the electrostatic analogues of magnets.

Polyethylene terephthalate:

PET is an acronym for polyethylene terephthalate, which is a long-chain polymer belonging to the generic family of polyesters. PET is formed from the intermediates, terephthalic acid (TPA) and ethylene glycol (EG), which are both derived from oil feedstock. There are other polyesters based on different intermediates but all are formed by a polymerisation reaction between an acid and an alcohol. PET, in its purest form, is an amorphous glass-like material. Under the influence of direct modifying additives it develops crystallinity. Also, crystallinity can be developed by heat treatment of the polymer melt.

The three major packaging applications of PET are as containers (bottles, jars and tubs), semi-rigid sheet for thermoforming (trays and blisters) and thin oriented films (bags and snack food wrappers).

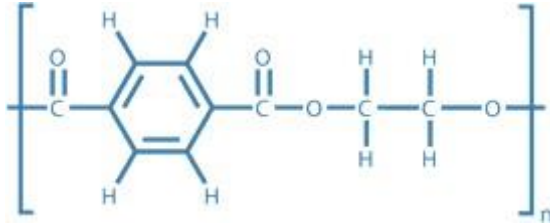

Properties:

PET in its natural state is a colorless, semi-crystalline resin. Based on how it is processed, PET can be semi-rigid to rigid, and it is very lightweight. It makes a good gas and fair moisture barrier, as well as a good barrier to alcohol (requires additional "barrier" treatment) and solvents. It is strong and impact-resistant. PET becomes white when exposed to chloroform and also certain other chemicals such as toluene.

About 60% crystallization is the upper limit for commercial products, with the exception of polyester fibers. Clear products can be produced by rapidly cooling molten polymer below T_g glass transition temperature to form an amorphous solid. Like glass, amorphous PET forms when its molecules are not given enough time to arrange themselves in an orderly, crystalline fashion as the melt is cooled. At room temperature the molecules are frozen in place, but, if enough heat energy is put back into them by heating above T_g, they begin to move again, allowing crystals to nucleate and grow. This procedure is known as solid-state crystallization.

When allowed to cool slowly, the molten polymer forms a more crystalline material. This material has spherulites containing many small crystallites when crystallized from an amorphous solid, rather than forming one large single crystal. Light tends to scatter as it crosses the boundaries between crystallites and the amorphous regions between them. This scattering means that crystalline PET is opaque and white in most cases.

<i>PET Product</i>	<i>Applications</i>
<i>Bottles</i>	<i>Beverages, soft drinks, fruit juices, and mineral waters. Especially suitable for carbonated drinks. Cooking and salad oils, sauces and dressings.</i>
<i>Wide mouth jars and tubs</i>	<i>Jams, preserves, fruits and dried foods</i>
<i>Trays</i>	<i>Pre-cooked meals for re-heating in either microwave or conventional ovens, pasta dishes, meats and vegetables</i>
<i>Films and metallised foils</i>	<i>'Boil in bag' pre-cooked meals, snack foods, nuts, sweets, long life confectionery, ice creams, and spreads</i>
<i>Coatings</i>	<i>Microwave susceptors</i>
<i>PET products with added oxygen barrier</i>	<i>Beer, vacuum packed dairy products e.g. cheese, processed meats, 'Bag in Box' wines, condiments, coffee, cakes, syrups.</i>

Acrylonitrile butadiene styrene:

- Acrylonitrile butadiene styrene (ABS) (chemical formula $(C_8H_8)_x \cdot (C_4H_6)_y \cdot (C_3H_3N)_z$) is a common thermoplastic polymer. Its glass transition temperature is approximately 105 °C (221 °F). ABS is amorphous and therefore has no true melting point.
- ABS is a terpolymer made by polymerizing styrene and acrylonitrile in the presence of polybutadiene. The proportions can vary from 15 to 35% acrylonitrile, 5 to 30% butadiene and 40 to 60% styrene.
- The result is a long chain of polybutadiene criss-crossed with shorter chains of poly(styrene-co-acrylonitrile).
- The nitrile groups from neighboring chains, being polar, attract each other and bind the chains together, making ABS stronger than pure polystyrene. The styrene gives the plastic a shiny, impervious surface.
- The polybutadiene, a rubbery substance, provides toughness even at low temperatures. For the majority of applications, ABS can be used between -20 and 80 °C (-4 and 176 °F) as its mechanical properties vary with temperature.
- The properties are created by rubber toughening, where fine particles of elastomer are distributed throughout the rigid matrix.

Properties:

- The most important mechanical properties of ABS are impact resistance and toughness. A variety of modifications can be made to improve impact resistance, toughness, and heat resistance.
- The impact resistance can be amplified by increasing the proportions of polybutadiene in relation to styrene and also acrylonitrile, although this causes changes in other properties.
- Impact resistance does not fall off rapidly at lower temperatures. Stability under load is excellent with limited loads.
- Thus, by changing the proportions of its components, ABS can be prepared in different

grades. Two major categories could be ABS for extrusion and ABS for injection moulding, then high and medium impact resistance. Generally ABS would have useful characteristics within a temperature range from -20 to 80 $^{\circ}\text{C}$ (-4 to 176 $^{\circ}\text{F}$).

Applications:

- ABS's light weight and ability to be injection moulded and extruded make it useful in manufacturing products such as drain-waste-vent (DWV) pipe systems, musical instruments (recorders, plastic clarinets, and piano movements), golf club heads (because of its good shock absorbance), automotive trim components, automotive bumper bars, medical devices for blood access, enclosures for electrical and electronic assemblies, protective headgear, whitewater canoes, buffer edging for furniture and joinery panels, luggage and protective carrying cases, small kitchen appliances, and toys, including Lego and Kre-O bricks. Household and consumer goods are the major applications of ABS. Keyboard keycaps are commonly made out of ABS.

3. Explain the following Engineering Ceramics:[A/M'15]

- a) Al_2O_3 b) SiC c) Si_3N_4

Al_2O_3

Aluminium oxide Alumina:

- Otherwise known as emery.
- Made from mineral bauxite.

Properties:

- Increase hardness and moderate strength.
- Withstand high voltage as well as temperature.
- Inexpensive and increase resistance to abrasion.
- Decrease density and increase electrical resisting
- Strong in compression

Application :

- Used in high temperature furnaces, because increase melting point.
- Used in grinding wheels because it has increase compressive strength and wear resistance.
- Used in rocket nozzles, pump impellers, check valves and nozzles subjected to erosion.
- Spark plugs, vacuum tubes and electronics micro circuits.

Silicon Carbide:

- Oldest ceramic material
 - Used for abrasives for grinding wheels and emery papers. Silicon are made from any one of the following four processes
- a) Pressureless sintering
 - b) reaction bonding
 - c) hot pressing
 - d) chemical vapour deposition
- Pressure less sintering - powder form heated with inert gas at 2050 $^{\circ}\text{C}$
 - Reaction bonding — silicon powder react with carbonaceous gases at high temperature.
 - Hot pressing — powder by uniaxial pressure at 2150 $^{\circ}\text{C}$. (pressure 30MPa)

properties :

- increase strength , stiffness and hardness
- increase thermal conductivity
- increase dimensional stability and polishability
- resistant to abrasion and wear
- increase chemical resistant.

Applications :

- Optical mirrors because of dimensional stability and polishability
- Used in nuclear reactor fuel elements.
- Used for mech seals, bearings and engine components.

Silicon Nitride:

Two main types of reaction bonding.

a) Silicon nitride and Pressure sintered silicon nitride it has 20% Porosity

- Advantage is low size change during firing.
- Disadvantage is decrease strength and mechanical properties.
- Pressure sintered silicon nitride has 100% theoretical density. Properties :
- Brittle and react with atmosphere.
- No loss of strength at temp 1000°C.
- Increase thermal shock resistance.
- Decrease thermal expansion
- Better toughness than Sic and Al₂O₃.
- Stiffer than steel.

Applications :

- Cutting tool materials
- Used in heat exchangers, furnace components and crucibles.
- Used in automobile industry.
- Used for gas turbine parts, resist thermal cycling.

4. i) Describe the difference between thermoplastics and thermosetting plastics.(8)

Property	Thermoplastics	Thermosetting plastics
Action of heat Type of bonding	They soften on heating and set on cooling every time	They set on heating and cannot be resoftened.
between adjacent polymer chains	The polymer chains are held together by weak force called Van der Waal's force of attraction.	The polymers chains are linked by strong chemical bonds.(covalent bonds)
Solubility Expansion due to	They are soluble in organic solvents.	They are insoluble in organic solvents.
Heating	They expand very much on heating.	Their expansion is only marginal due to heat.
Type of polymerisation	They are formed by addition polymerization	They are formed by condensation polymerization
Type of moulding Scrap recovery	They are processed by injection moulding.	They are processed by compression moulding.

Example	Scarp can be reused. Polythene, PVC, Nylon	Scarp cannot be reused. Bakelite, Plaskon
---------	---	--

ii) What do you understand by polymerization? With the help of suitable examples, compare and contrast the process of addition polymerization and condensation polymerization. [M/J'16]

- ❖ Polymer means many monomers. Sometimes polymers are also known as macromolecules or large-sized molecules. Usually, polymers are organic (but not necessarily).
- ❖ A monomer is a molecule that is able to bond in long chains.
- ❖ A polymer can be made up of thousands of monomer. This linking up of monomers is called polymerization.
- ❖ Polymerization is a process of reacting monomer molecules together in a chemical reaction to form polymer chains or three-dimensional networks.

Name(s)	Formula	Monomer	Properties	Uses
Polyethylene low density (LDPE)	$-(\text{CH}_2-\text{CH}_2)_n-$	ethylene $\text{CH}_2=\text{CH}_2$	soft, waxy solid	film wrap, plastic bags
Polyethylene high density (HDPE)	$-(\text{CH}_2-\text{CH}_2)_n-$	ethylene $\text{CH}_2=\text{CH}_2$	rigid, translucent solid	electrical insulation bottles, toys
Polypropylene (PP) different grades	$-(\text{CH}_2-\text{CH}(\text{CH}_3))_n-$	propylene $\text{CH}_2=\text{CHCH}_3$	<u>atactic</u> : soft, elastic solid <u>isotactic</u> : hard, strong solid	similar to LDPE carpet, upholstery
Poly(vinyl chloride) (PVC)	$-(\text{CH}_2-\text{CHCl})_n-$	vinyl chloride $\text{CH}_2=\text{CHCl}$	strong rigid solid	pipes, siding, flooring

iii) Difference between addition polymerization and condensation polymerization

Addition polymerization	Condensation polymerization
-------------------------	-----------------------------

The addition polymerization means that two monomers react with each other and no other small molecules are generated. The best example is polymerization of ethylene.	The condensation polymerization, as a contrast, normally involves the generation of small molecule products.
It requires two like molecules.	It requires two unlike molecules.
Kinetic long linear chain reaction.	Intermolecular reaction.
Very fast reaction $10^{-2} - 10^{-6}$ sec	Slow reaction takes hours and days to complete.
No by total.	By product it produced.
Polymer produced thermoplastic.	Chemo setting plastic produced.
Example: PVC, Teflon, Poly ethylene.	Example: Bakelite, Silicon, GRP, Polystyrene.

PART-C

1. Write properties and applications for a) ZrO₂ (b) SIALON

a) Zirconium oxide:

- Otherwise known as partially stabilized Zirconia.
- It is blended and sintered with other oxide such of magnesium oxide or Calcium oxide to control crystal structure transformation.
- It has monoclinic crystal structure at room temperature.
- Tetra gonal structure at low temperature.
- Cubic structure at high temperature.
- Cooling curves cracking and it is difficult to fabricate pure Zirconia ceramic. Properties :
- Better fracture toughness than ceramics

- Softer than ceramics.
- Increase tensile strength.
- Increase thermal insulators.
- Increase resistance to thermal shock, wear and corrosion.

Applications:

- Used in IC engines.
- Hot extrusion of metal, aerospace, coating etc.

b) Sialon: $\text{Si}_3\text{Al}_3\text{O}_3\text{N}_5$

- It is formed by blending and sintering silicon nitride, alumina, silica and aluminium nitride.
- Presence of Aluminium oxide in sialon increases hardness because of presence of silicon nitride increases toughness.

Two commercial varieties of sialon.

a) low substitutional sialon b) high substitution sialon properties :

- Increase strength and hardness.
- Increase resistance to corrosion, wear and thermal shocks.
- Used as electrical insulator.
- Good tensile and compressive strength up to 1400°C.
- Increase stability dimensionally and increase coefficient of thermal expansion.

Application :

- Used in cutting tool materials.
- Used for engine components and bearings.

2. Name the suitable alloys, polymers and ceramics for manufacturing the following items.

(i) Bush (ii) Furnace heating element (iii) Lathe bed

(iv) Coins (v) Girders for airship (vi) Big end bearing (vii) Knobs

viii) Windshields ix) Conduit pipes (xi) Touch screen (xii) Turbine blade

(xiii) Furnace linings (xiv) Grinding (abrasive) wheels (xv) Coating on cutting inserts

(xvi) Cutting inserts for ferrous alloys

1. Bush - Polyamides
2. Furnaces heating element - Ferritic stainless steel
3. Lathe bed - Cast iron
4. Coins - Gliding metal or bronze
5. Girders for Airship - Aluminium/ austenitic stainless steel
6. Big end Bearing - Aluminium base bearing
7. Turbine Blade - Inconel/ monel metal
8. Conduit Pipes - PVC
9. Knobs - Styrene acrylo-nitrile copolymer SAN
10. Windshields - Acrylic plastic
11. Touch Screens - Indium tin oxide ITO
12. Furnace lining - Refractories/ceramics
13. Grinding (abrasive) wheels - Abrasives/ceramics
14. Coating on cutting inserts - Diamond

15. cutting inserts for ferrous alloy - cemented carbides

ME8491 EM SACET

UNIT – 5

MECHANICAL PROPERTIES AND DEFORMATION MECHANISMS

PART: A

1. Define the term elasticity and plasticity.

Elasticity: It is the property of a material by virtue of which it is able to retain its original shape and size after the removal of the load.

Plasticity: It is the property of a material by virtue of which permanent deformation takes place, whenever it is subjected to the action of external force.

2. What are the factor affecting mechanical properties?

The numbers of factor affect mechanical properties, the following factors are:

- Grain size
- Heat treatment
- Atmospheric exposure
- Low and high temperature

3. Classify the different hardness testing methods. [N/D'16]

1. Rockwell hardness test
2. Brinell hardness test
3. Vickers hardness test

4. What are the different types of fracture?

Ductile, Fatigue, Creep

5. Why impact specimen is notched?

The impact specimens are notched because the impact test also indicates the notch sensitivity of material.

6. Define creep.

Creep is defined as the slow and progressive deformation of materials with time under a constant stress at temperature approximately above $0.4 T_m$. Where T_m is melting point of metal in $^{\circ} K$.

7. Define endurance limit in fatigue test.

The value of limiting stress below which a load may be applied repeatedly for an indefinitely large of time is called as endurance limit for fatigue test.

8. Define toughness, modulus of toughness and ductility.

- I) Toughness is the total amount of energy absorbed by a materials before its failure.
- II) Modulus of toughness is the total energy absorbed by the materials before failure per unit volume. $MOT = TOUGHNESS / VOLUME$.
- III) Ductility is the ability of a material to undergo plastic deformation under tensile loading before fracture.

9. Distinguish between slip and twinning

It is defined as the shear transformation, which moves the atoms over a number of interatomic distances relative to their initial position.

It is the plastic deformations which takes place along two planes due to set of forces acting on a given metal.

10. Distinguish between elasticity and plasticity. [M/J'16]

Elasticity	plasticity
Deformation disappears when external load is removed	Permenant deformation occurs.
Obeys hook's law	Does not obey hook's law

11. What are the factors affecting creep?

Grain size Thermal stability

Chemical reaction
Prior strain

PART: B

1. Explain the two modes of Plastic deformation. Describe the working of universal testing machine with suitable diagram. [N/D'16]

- ❖ In a tensile test of mild steel specimen, usually a round or flat bar is gradually pulled in a testing machine until it breaks.
- ❖ Two points, called gauge points, are marked on the central portion. The distance between these points, before the application of the load, is called gauge length of the specimen.
- ❖ The Load is applied gradually and at regular interval of loads extension is measured.
- ❖ The strains corresponding to the recorded extensions are calculated by dividing the extensions by the gauge length, while the stresses are calculated by dividing the loads by the original area of cross-section of the specimen.
- ❖ Stresses so arrived at is called nominal stress to distinguish it from actual stress which is obtained by dividing the load at a particular instant by the area of the cross-section at that instant

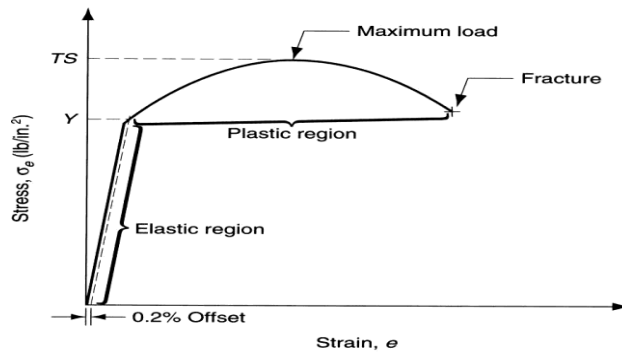

Stress-Strain Diagram

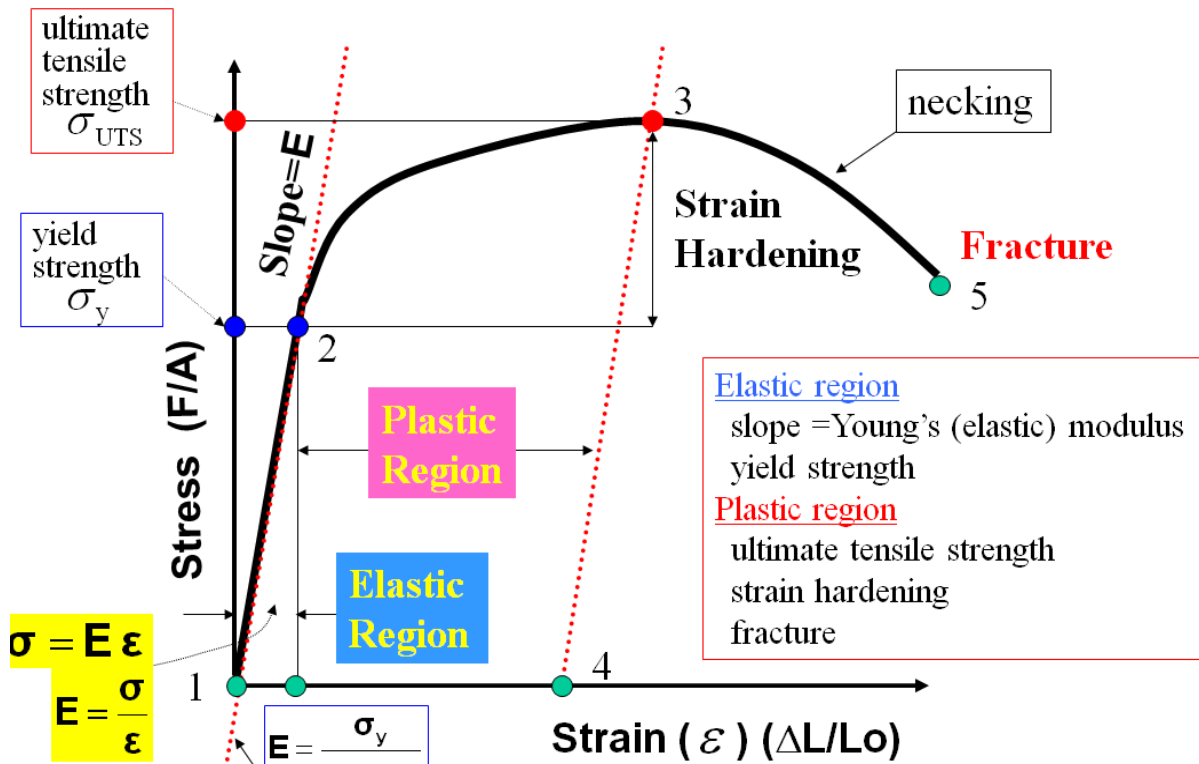

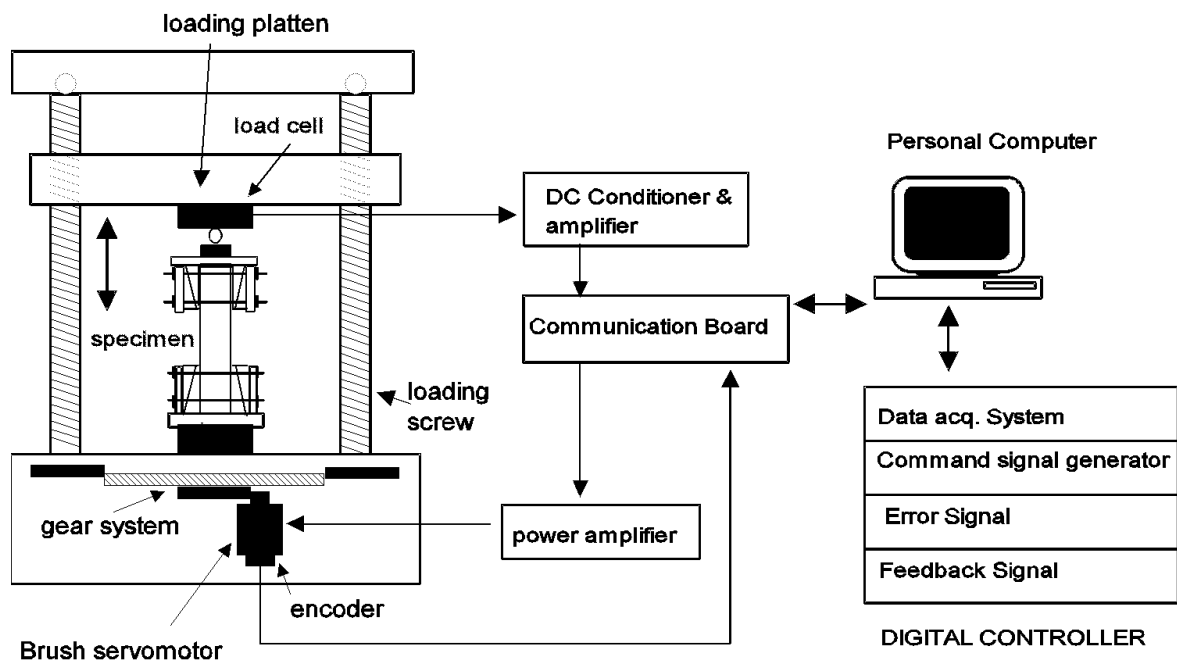

2. Write down the procedure for preparing Charpy and Izod specimens for impact testing and also explain how testing is performed? (N/D2009)

Impact Test

Impact Testing, ASTM E23 and IS/ BS Standard

The impact test is a method for evaluating the toughness and notch sensitivity of engineering materials. It is usually used to test the toughness of metals, but similar tests are used for polymers, ceramics and composites. Metal industry sectors include Oil and Gas, Aerospace, Power Generation, Automotive, and Nuclear.

The notched test specimen is broken by the impact of a heavy pendulum or hammer, falling at a predetermined velocity through a fixed distance. The test measures the energy absorbed by the fractured specimen.

Charpy Impact Test

A test specimen is machined to a 10mm x 10mm (full size) cross-section, with either a -V|| or -U|| notch. Sub-size specimens are used where the material thickness is restricted. Specimens can be tested down to cryogenic temperatures.

Izod Impact Test

The test specimen is machined to a square or round section, with either one, two or three notches. The specimen is clamped vertically on the anvil with the notch facing the Hammer.

Keyhole Impact Test

The steel casting industry uses this type of specimen more frequently. The notch is machined to look like a keyhole. It is tested in the same manner as the -V|| and -U|| notch.

Charpy Impact Test PRINCIPLE The Charpy impact test is a dynamic test in which a test piece U-notched or V-notched in the middle and supported at each end, is broken by a single blow of a freely swinging pendulum (Fig.1). The energy absorbed is measured. This absorbed energy is a measure of the impact strength of material.

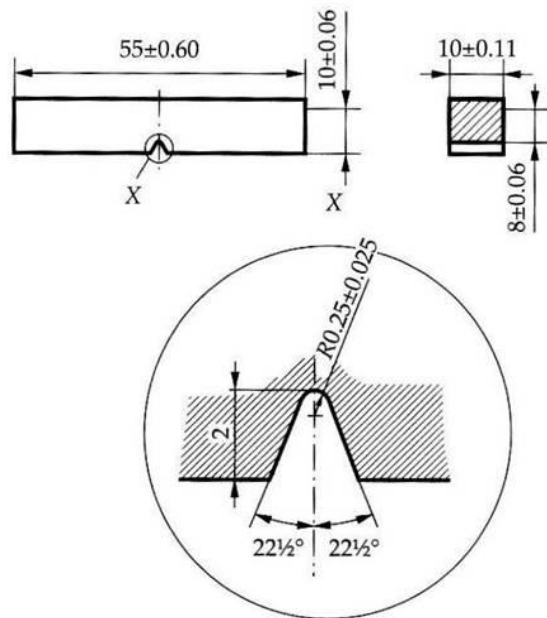

(b) Charpy V-notch impact test piece

PRINCIPLE

The Izod impact test is a dynamic test in which a test piece V-notched test piece, gripped vertically, is broken by a single blow of a freely swinging pendulum (Fig.4). The blow is struck on the same face as the notch and at the fixed height above it. The energy absorbed is measured. This absorbed energy is a measure of the impact strength of material.

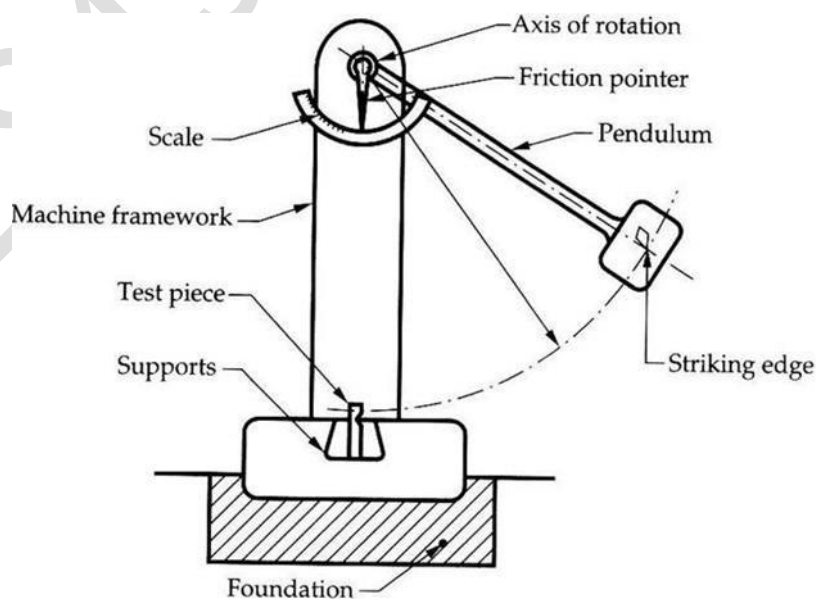

(Dimensions in millimetres)

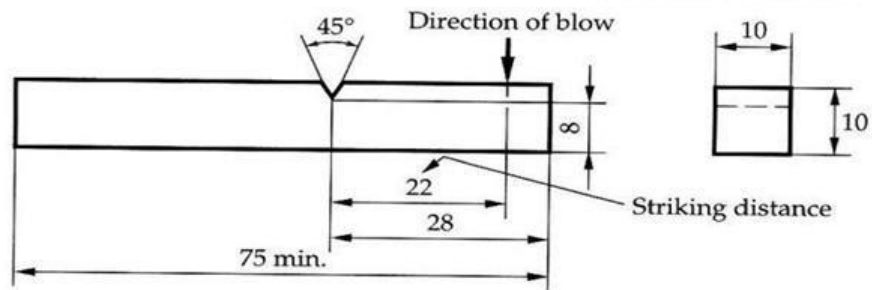

(a) Single-notch square section test piece

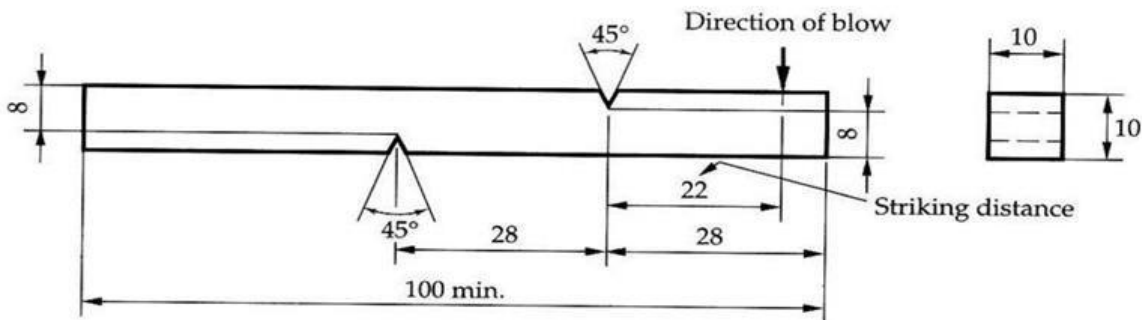

(b) Two-notch square section test piece

3. Explain the mechanism of plastic deformation by slip and twinning with neatsketch. [N/D'15]

Two modes of plastic deformation may occur.

They are slip and twinning.

Slip:

Slip is defined as a shear deformation that moves atoms by mass inter atomic distance in one crystal plane over the atoms of another crystal plane. The combination of a slip plane and slip direction is known as slip system.

This slip system for FCC lattice.

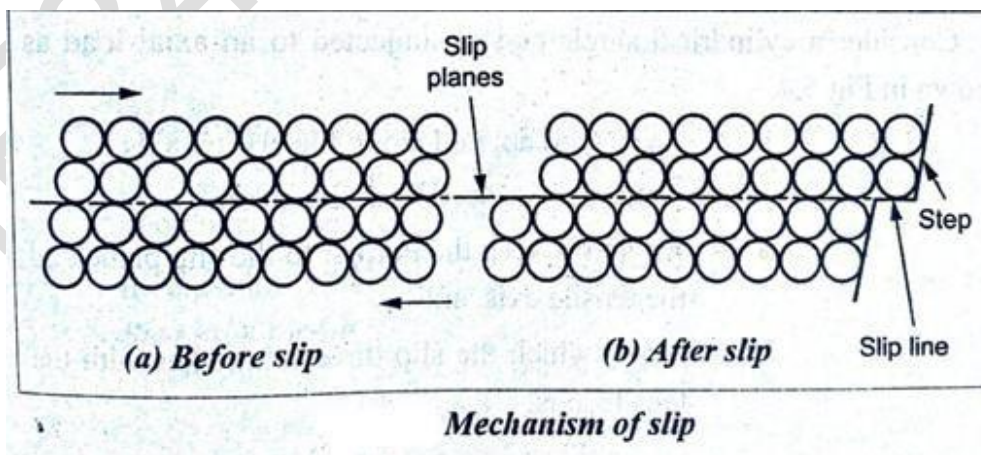

Mechanism of slip:

The mechanism of slip is actually due to the movement or dislocation in the crystallattice.

- ✓ The slip mode of deformation is the common mode in many crystals at elevated temperatures.
- ✓ By examination of the surfaces of a deformed crystal under microscope shows of parallel lines which corresponded to steps on the surfaces. They are called as slip lines.
- ✓ The mechanism of slip requires the growth and movement of dislocation line.
- ✓ Therefore the energy required for this movement of dislocation line is given by the relation.

Where, E – Young's modulus

L – length of dislocation line

G – Shear modulus

b – Unit slip vector

The energy required will be minimum when b vector and g are having the lowest value.

- It means that the dislocation having the shortest slip vector is the easiest dislocation to generate and expand for plastic deformation by slip.
- Critical resolved shear stress for slip:

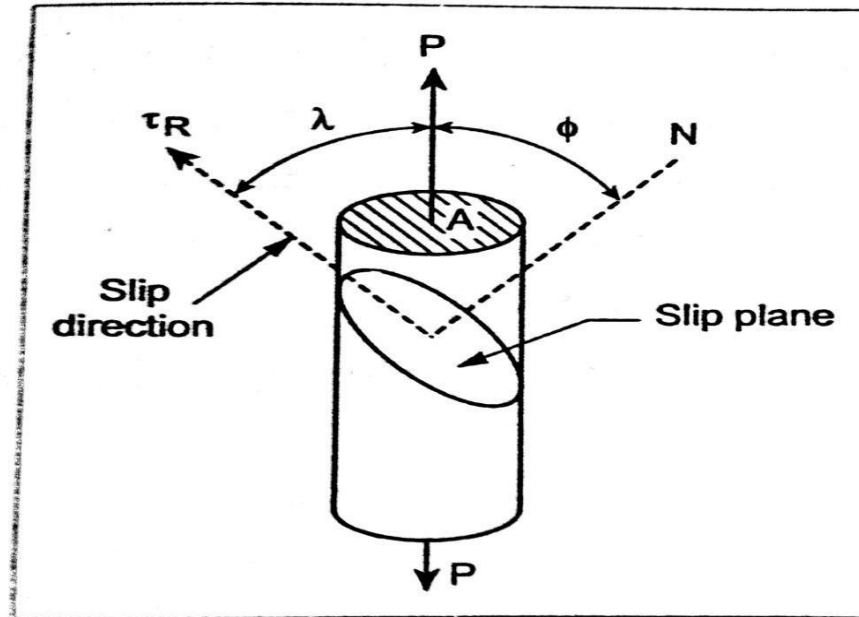

Fig. 5.1

The stress at which slip starts in a crystal depends on the relative orientations of the stress axis with respect to the slip plane and the slip direction. The resolved shear stress, which is in the actual stress operating on the slip system resulting from the application of simple tensile stress.

F – externally applied forces perpendicular to the cross sectional area. A – Area of single crystal sample.

This resolved shear stress should reach a critical value called as critical resolved shear stress for a plastic deformation to start. The important concept here is that the fundamental deformation mechanism is a shearing action based on the projection of the applied force onto the slip system.

F – applied force along the crystal area

A – area of the crystal

ϕ – angle between normal to slip plane and F

- Angle between normal to the slip direction and F

A value of τ to produce slip by dislocation motion is called as CRSS and is given by

A. Mechanical twins:

- As a result of mechanical deformation of crystals, twins may occur and these twins that occur during mechanical deformation are called mechanical twin.

B. Annealing Twins:

- The twins that are produced by annealing are called as annealing twins. Most of FCC metals form annealing twins.

Mechanism of Twinning :

In twinning process, the movement of atoms is only a fraction of inter atomic distance. The circles indicating the arrangement of atoms. The line AB and CD represents the planes of symmetry, from where the twinning starts and ends respectively. These planes are known as twinning planes.

Where

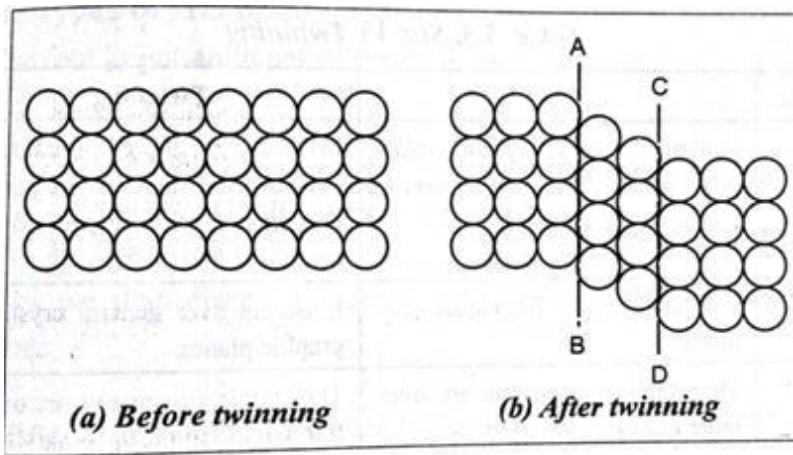

Mechanism of twinning

AB and the right of the twinning plane CD remain undisturbed. Whereas in the twinned region each atom moves by a distance proportional to its distance from the twinning plane AB. The dark circular indicated the new position of the atoms.

The twinning occurs due to the growth and movement of dislocation in the crystal lattice. Definition of twinning:

- Twinning is that process by which a portion of the crystal takes up an orientation which makes that portion a mirror image of the parent crystal.
- Twinning is the plastic deformation which takes place along two planes due to a set of forces acting on a given metal.
- The two planes are usually parallel to each other and are called the twin planes. Here each atom moves only a fraction of an inter atomic distance to its neighbor. The deformation of the crystal lattice caused by twinning.

Twinning planes:

- The planes where the twinning almost takes place is known as twinning plane. These planes are also called as special planes.
- In most plastic deformation, twinning is relatively insignificant but it may have considerable influence on the total amount of deformation that occurs.

Types of twinning:

There are two types of twins

- a) Mechanical twins b) Annealing Twins

Difference between slip and twinning: Slip :

- Slip is associated with line defect.
- Stress required to slip is less than in twinning.
- Slip is more common in BCC and FCC metals.
- The slipped portion has the same orientation.
- Slip lines disappear after polishing the surfaces.
- Slip takes several seconds to form.
- During formation of slip level sound not heard.
- The atomic movements are over large atomic distance.

Twinning :

- Twinning is higher than slip when stress produced.
- Twinning is more common in HCP.
- The twinning portion is a mirror image of original lattice.
- Twin remains even after polishing the surface.
- Twin can form in a few microseconds.
- During twin formation, a loud sound called twin cry can be heard.

4. Explain the testing procedure for determining the following properties.

(i) Rockwell hardness test (8) [M/J'16]

(ii) Brinell hardness number (4)

(iii) Vickers hardness test (4)

Rockwell Hardness Test

The Rockwell hardness test method consists of indenting the test material with a diamond cone or hardened steel ball indenter. The indenter is forced into the test material under a preliminary minor load F_0 (Fig. 1A) usually 10 kgf. When equilibrium has been reached, an indicating device, which follows the movements of the indenter and so responds to changes in depth of penetration of the indenter is set to a datum position. While the preliminary minor load is still applied an additional major load is applied with resulting increase in penetration (Fig. 1B). When equilibrium has again been reached, the additional major load is removed but the preliminary minor load is still maintained. Removal of the additional major load allows a partial recovery, so reducing the depth of penetration (Fig. 1C). The permanent increase in depth of penetration, resulting from the application and removal of the additional major load is used to calculate the Rockwell hardness number.

$$HR = E - e$$

F_0 = preliminary minor load in kgf

F_1 = additional major load in kgf

F = total load in kgf

e = permanent increase in depth of penetration due to major load F_1 measured in units of 0.002 mm

E = a constant depending on form of indenter: 100 units for diamond indenter, 130 units for steel ball indenter

HR = Rockwell hardness number

D = diameter of steel ball

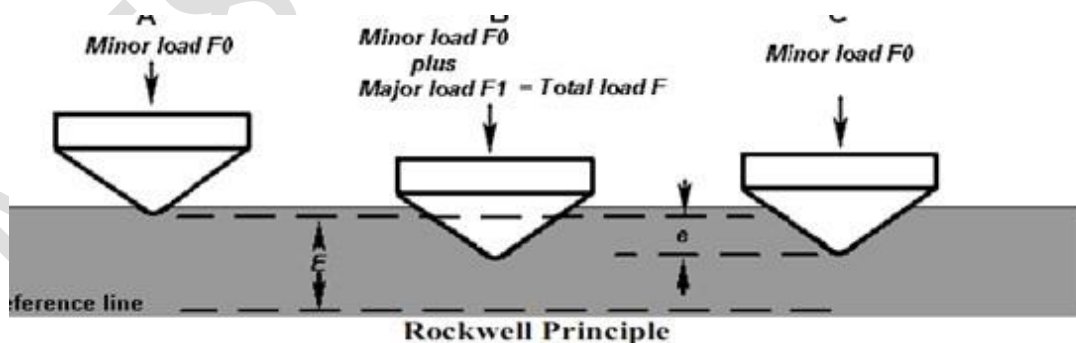

Rockwell Hardness Scales

Scale	Indenter	Minor Load F_0 kgf	Major Load F_1 kgf	Total Load F kgf	Value of E
A	Diamond cone	10	50	60	100
B	1/16" steel ball	10	90	100	130
C	Diamond cone	10	140	150	100
D	Diamond cone	10	90	100	100
E	1/8" steel ball	10	90	100	130
F	1/16" steel ball	10	50	60	130
G	1/16" steel ball	10	140	150	130
H	1/8" steel ball	10	50	60	130
K	1/8" steel ball	10	140	150	130

Typical Application of Rockwell Hardness Scales

- HRA Cemented carbides, thin steel and shallow case hardened steel
- HRB Copper alloys, soft steels, aluminium alloys, malleable irons, etc
- HRC Steel, hard cast irons, case hardened steel and other materials harder than 100 HRB
- HRD Thin steel and medium case hardened steel and pearlitic malleable iron
- HRE Cast iron, aluminium and magnesium alloys, bearing metals
- HRF Annealed copper alloys, thin soft sheet metals
- HRG Phosphor bronze, beryllium copper, malleable irons
- HRH Aluminium, zinc, lead
- HRK }
- HRL }
- HRM } Soft bearing metals, plastics and other very soft materials
- HRP }
- HRR }
- HRS }
- HRV }

The Brinell Hardness Test

The Brinell hardness test method consists of indenting the test material with a 10 mm diameter hardened steel or carbide ball subjected to a load of 3000 kg. For softer materials the load can be reduced to 1500 kg or 500 kg to avoid excessive indentation. The full load is normally applied for 10 to 15 seconds in the case of iron and steel and for at least 30 seconds in the case of other metals. The diameter of the indentation left in the test material is measured with a low powered microscope. The Brinell hardness number is calculated by dividing the load applied by the surface area of the indentation.

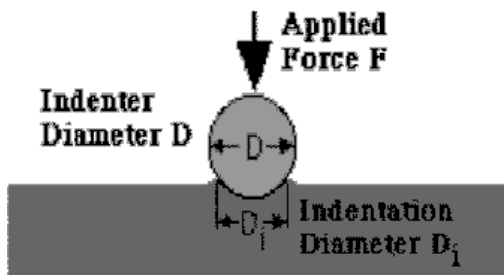

$$\text{BHN} = \frac{F}{\frac{\pi}{2} D (D - \sqrt{D^2 - D_i^2})}$$

The diameter of the impression is the average of two readings at right angles and the use of a Brinell hardness number table can simplify the determination of the Brinell hardness. A well structured Brinell hardness number reveals the test conditions, and looks like this, —75 HB 10/500/30| which means that a Brinell Hardness of 75 was obtained using a 10mm diameter hardened steel with a 500 kilogram load applied for a period of 30 seconds. On tests of extremely hard metals a tungsten carbide ball is substituted for the steel ball. Compared to the other hardness test methods, the Brinell ball makes the deepest and widest indentation, so the test averages the hardness over a wider amount of material, which will more accurately account for multiple grain structures and any irregularities in the uniformity of the material. This method is the best for achieving the bulk or macro-hardness of a material, particularly those materials with heterogeneous structures.

Vickers Hardness Test

The Vickers hardness test method consists of indenting the test material with a diamond indenter, in the form of a right pyramid with a square base and an angle of 136 degrees between opposite faces subjected to a load of 1 to 100 kgf. The full load is normally applied for 10 to 15 seconds. The two diagonals of the indentation left in the surface of the material after removal of the load are measured using a microscope and their average calculated. The area of the sloping surface of the indentation is calculated. The Vickers hardness is the quotient obtained by dividing the kgf load by the square mm area of indentation.

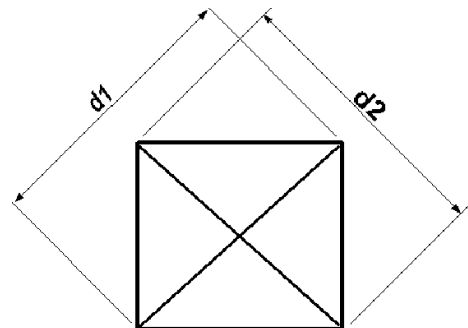
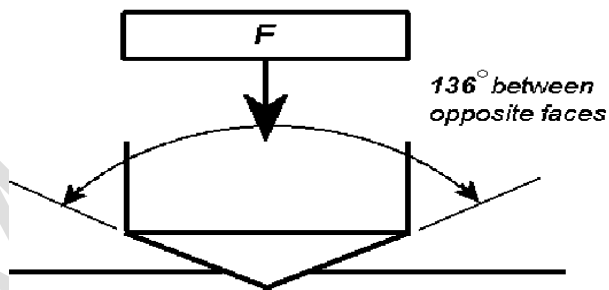

F = Load in kgf

d = Arithmetic mean of the two diagonals, $d1$ and $d2$ in mm

HV = Vickers hardness

$$HV = \frac{2F \sin \frac{136^\circ}{2}}{d^2} \quad HV = 1.854 \frac{F}{d^2} \text{ approximately}$$

When the mean diagonal of the indentation has been determined the Vickers hardness may be calculated from the formula, but is more convenient to use conversion tables. The Vickers hardness should be reported like 800 HV/10, which means a Vickers hardness of 800, was obtained using a 10 kgf force. Several different loading settings give practically identical hardness numbers on uniform material, which is much better than the arbitrary changing of scale with the other hardness testing methods. The advantages of the Vickers hardness test are that extremely accurate readings can be taken, and just one type of indenter is used for all types of metals and surface treatments. Although thoroughly adaptable and very precise for testing the softest and hardest of materials, under varying loads, the Vickers machine is a floor standing unit that is more expensive than the Brinell or Rockwell machines.

There is now a trend towards reporting Vickers hardness in SI units (Mpa or Gpa) particularly in academic papers. Unfortunately, this can cause confusion. Vickers hardness (e.g. HV/30) value should normally be expressed as a number only (without the units kgf/mm²). Rigorous application of SI is a problem. Most Vickers hardness testing machines use forces of 1, 2, 5, 10, 30, 50 and 100 kgf and tables for calculating HV. SI would involve reporting force in newtons (compare 700 HV/30 to HV/294 N = 6.87 Gpa) which is practically meaningless and messy to engineers and technicians. To convert a Vickers hardness number the force applied needs converting from kgf to newtons and the area needs converting from mm² to m² to give results in pascals using the formula above.

To convert HV to Mpa multiply by 9.807

To convert HV to Gpa multiply by 0.009807

PART-C

Sketch and describe the fatigue test.

Fatigue test:

The failure test of a material under repeatedly applied stress is called fatigue. Machine parts such as shaft, axles, pinion teeth etc are subjected to varying stresses, the loading may be either the same type of stress or change from tensile to compressive varying stresses can be classified into the following four types.

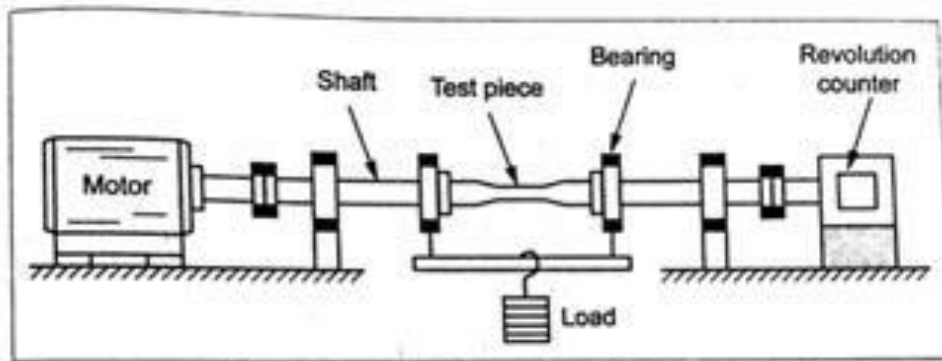

Rotating beam fatigue testing machine

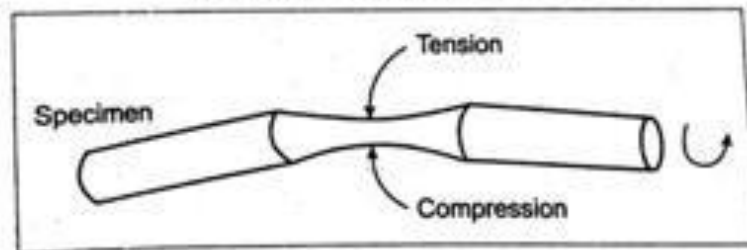

1. Stress varying between two limits of equal value, but opposite sign.
2. Stress between two unequal values but opposite sign.
3. Stress between zero and a definite value.
4. Stress between two limits of unequal values but of same sign.

The specimen is loaded in pure bending and rotated with the help of a motor. In this case, with each rotation all the points on the circumference of the specimen will alternate between tension and compression. Each revolution will have several of stresses and the speed to revolution of the motor will indicate the frequency of this reversal.

While doing the test, a number of test pieces are made from the same material. The first test pieces are made from is loaded on the machine and motor is started. Generally this load should not be less than that which can create a stress equal to $\frac{3}{4}$ of the tensile stress of the specimen. The speed of the shaft should be constant. After a number of cycles, it will be found that a crack will appear on the surface of the specimen in the form of a ring.

This will keep increasing until the specimen breaks. The second test piece is loaded and is tested with a decreased load. In the same way the test pieces are tested with the load being decrease each time. After some tests, a limit is reached where the stress is not enough to break the specimen even after 10×10^6 . This safe stress ie the stress which does not cause the piece to break is called the endurance limit or fatigue limit.

Fatigue limit:

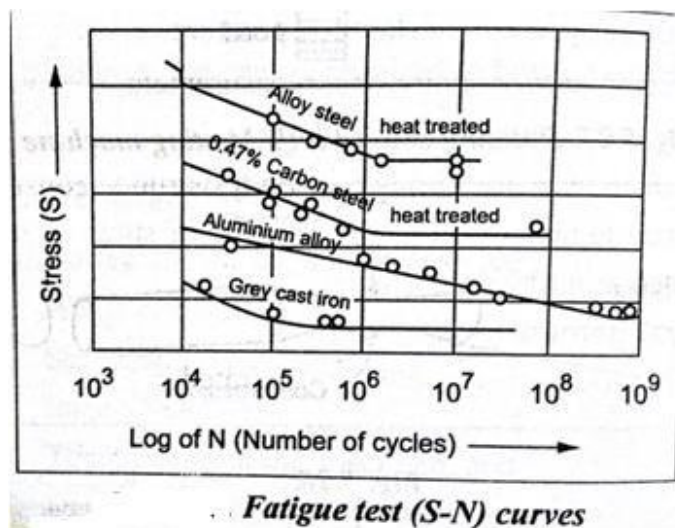

The fatigue limit test results are then plotted on a graph called an s-n graph. This has the stress on the y-axis and the number of cycles on the x-axis.

There are two types of fatigue that are normally found by means of using this apparatus.

1. Low cycle fatigue
2. High cycle fatigue

Low cycle fatigue:

The specimen is subjected to very high loads which result in plastic and elastic deformation that finally results in failure of the specimen on repeated loading.

High cycle fatigue:

The specimen is subjected to low loads which result in elastic deformation. The failure of the specimen happens when the number of cycles is greater than 10⁵ cycles on a logarithmic scale.

Differentiate between ductile fracture and brittle fracture.

A fracture is considered as a brittle one when it takes place with the minimum of plastic deformation and very rapid crack propagation. It consists of destroying the interatomic bonds with normal stresses.

- In crystalline materials the fracture takes place normal to specific crystallographic planes called cleavage planes.
- Brittle fracture also occurs along the grain boundaries in polycrystalline materials.

Ductile fracture:

- A ductile fracture can be defined as a fracture which is the result of intense localized plastic deformation of metal at the tip of the crack.
- At elevated temperatures all fractures tend to become ductile because slip can occur more easily.
- Ductile fracture is a less serious problem and compared to brittle fracture it is slow and

occurs with the temperature of large amount of energy.

ii). Draw creep curve and explain the different stages of creep damage. [N/D'16]

Creep is the slow and progressive deformation of a materials with time under a constant stress at a temperature approximately above $0.4 T_m$.

Creep curve:

The creep is tested for a material by subjected the specimen at constant tensite stress at constant temperature and measuring the extent of strain or deformation with respect to time.

The three stages of elongation are

1. Primary (or) Transient creep
2. Secondary (or) Steady state creep
3. Tertiary (or) accelerated creep

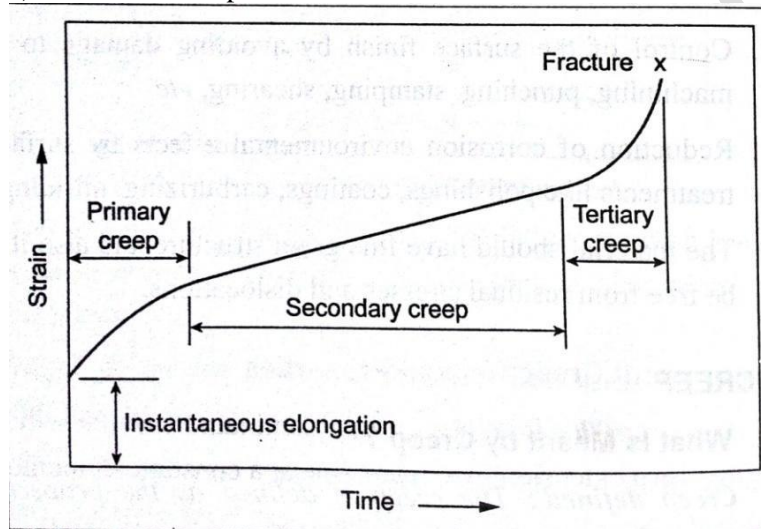

Primary creep:

- In this stage, strain hardening effect occurs and the deformation is slow at a decreasing rate for low melting temperature metal, primary creep is the predominant creep process.

Secondary creep:

- In this stage, the creep is constant and the creep rate is constant. This is due to an equilibrium between the strain hardening effect and the annealing effect. Hence there is a balance between the strain hardening effect and the annealing effect which results steady state creep.

Tertiary creep:

- In this the final stage of creep before fracture creep occurs rapidly due to decrease in cross sectional area and necking of the specimen occurs, the true stress increase rapidly.
- During this stage, there is a progressive damage to the inter crystalline region by the formation of voids and severe oxidation of the metal. The material is unable to harden and finally fractures.

9. Draw a typical creep curve for ductile metal and explain the regions.
10. Draw a typical load versus percentage elongation curve for ductile material and explain the tensile properties.

PART B — (5 × 16 = 80 marks)

11. (a) Neatly sketch labeled Iron-Carbon equilibrium diagram. Name, write and explain the reactions involved.

Or

- (b) Explain the procedural steps for constructing the binary phase diagram where the components show complete liquid and solid solubility. Draw the labeled diagram and name the system. Give one example for the alloy system showing above mentioned behavior.
12. (a) Draw a neat sketch of the Isothermal Transformation diagram for Eutectoid steel and explain the constructional procedure. Label all the salient features on it. Superimpose on it a cooling curve to obtain bainitic phase.

Or

- (b) Differentiate hardness and hardenability. Explain with a neat sketch, the procedure to plot the hardenability curves for eutectoid steel in Jominy End Quench Test.
13. (a) Classify Stainless steel and tool steels and explain the following :
- (i) Maraging steel (5)
 - (ii) Spheroidal graphite iron (5)
 - (iii) High speed steel in terms of composition, property and use. (6)

Or

- (b) With part of phase diagram and relevant graphs explain precipitation hardening treatment of Al-Cu alloy.
14. (a) Name, explain the properties and application of any eight varieties of polymers used as engineering materials.

Or

- (b) Name, explain the properties and application of any four types of ceramics.

15. (a) Name and explain the different types of hardness tests with respect to the procedure, relative advantages and disadvantages.

Or

- (b) With geometry and arrangement of impact test specimens explain Charpy and Izod test with relative advantages and disadvantages.
-

Reg. No. :

--	--	--	--	--	--	--	--	--	--	--	--	--	--	--	--	--	--	--	--

Question Paper Code : 27362

B.E./B.Tech. DEGREE EXAMINATION, NOVEMBER/DECEMBER 2015.

Third Semester

Manufacturing Engineering

ME 6403 — ENGINEERING MATERIALS AND METALLURGY

(Common to Fourth Semester Automobile Engineering, Mechanical and Automation Engineering and Mechanical Engineering)

(Regulations 2013)

Time : Three hours

Maximum : 100 marks

Answer ALL questions.

PART A — (10 × 2 = 20 marks)

1. Draw a typical cooling curve of pure metal and a solid solution.
2. What do you mean by invariant reaction?
3. What do you mean by hardenability?
4. Which type of surface hardening process that does not involve composition change?
5. Which type of stainless steel is used for surgical instruments?
6. What is the typical constituent microstructure of bearing alloy?
7. What are the outstanding properties of PMMA?
8. List the typical applications of Al_2O_3 .
9. What are the characteristic features of fracture surface of creep rupture component?
10. State the advantages of Rockwell hardness testing over other techniques.

PART B — (5 × 16 = 80 marks)

11. (a) (i) Draw Iron–Iron carbide phase diagram, name the various field, line and reactions. (10)
- (ii) Draw the typical microstructure of 0.5% C steel at 920° C, 780° C and 200° C. (6)

Or

- (b) (i) Discuss on substitutional solid solution. (8)
- (ii) Compare the microstructure, properties and application of any TWO kind of cast iron. (8)
12. (a) (i) Brief on hardening and tempering of steel with respect to rate of cooling and tempering temperature respectively. (8)
- (ii) Compare Austempering and Martempering. (8)

Or

- (b) (i) Brief on Jominy end quench test and interpretation of results. (8)
- (ii) Brief on the types of carburizing and need for post carburizing heat treatments. (8)
13. (a) (i) Brief on the influence of alloying elements in steel under classification of carbide former and non carbide former. (8)
- (ii) List the types and their typical applications of stainless steel. (8)

Or

- (b) (i) What are the types of titanium alloy, their composition, properties and applications? (8)
- (ii) Brief on the precipitation hardening and ageing treatment of Al-Cu alloy. (8)
14. (a) (i) Classify composite materials and list TWO properties and application of them. (12)
- (ii) State the properties and applications of PSZ or SiC. (4)

Or

- (b) (i) Classify engineering ceramics and list properties and applications of any TWO of them. (8)
- (ii) Brief on properties and applications of any TWO polymers from the list: PTFE, PC, PET, ABS and PS. (8)

15. (a) (i) Compare Charpy and Izod Impact test. (4)
(ii) List the applications of impact test. (4)
(iii) Draw a typical creep curve and brief on the mechanism. (8)

Or

- (b) (i) Discuss the role of slip and twinning in plastic deformation of materials. (8)
(ii) Draw a typical S-N curve of fatigue testing and brief on the mechanism. (8)
-

Reg. No.

--	--	--	--	--	--	--	--	--	--	--	--	--	--	--	--	--	--	--	--

Question Paper Code : 57553

B.E./B.Tech. DEGREE EXAMINATION, MAY/JUNE 2016

Fourth Semester

Mechanical Engineering

ME 6403 – ENGINEERING MATERIALS AND METALLURGY

(Common to Automobile Engineering, Mechanical and Automation Engineering and also common to Third Semester Manufacturing Engineering)

(Regulations 2013)

Time : Three Hours

Maximum : 100 Marks

Answer ALL questions.

PART – A (10 × 2 = 20 Marks)

1. State Gibbs phase rule.
2. Give the typical eutectic and eutectoid reactions.
3. What is austempering ?
4. Name any two shallow hardening processes.
5. Give the effects of Silicon on steel.
6. What are bearing alloys ? Give an example.
7. What is polymerization ?
8. State the advantages of fiber reinforced composites.
9. List the applications of engineering ceramics.
10. Distinguish between elasticity and plasticity.

PART - B (5 × 16 = 80 Marks)

11. (a) Explain with a neat sketch of iron-iron carbide equilibrium diagram and indicate all the phases. Also write the three important invariant reactions. (16)

OR

- (b) Explain the various classification of steels and Cast Iron with microstructure, properties and applications. (16)

12. (a) What is hardenability ? How is Jominy end quench test used to measure hardenability ? (16)

OR

- (b) Explain TTT diagram with neat sketch and indicate all the phases with microstructure. (16)

13. (a) Discuss the properties and the applications of the following :
(i) Tool steels (ii) HSLA (8 + 8)

OR

- (b) Explain age hardening of Al-Cu with the help of phase diagram. (16)

14. (a) What is polymerization ? Explain addition polymerization and condensation polymerization with examples. (16)

OR

- (b) What is strengthening mechanism ? Explain the strengthening mechanism of fiber-reinforced composites. (16)

15. (a) Define hardness. Explain Brinell and Rockwell hardness test with neat sketches. (16)

OR

- (b) Explain the mechanism of plastic deformation by slip and twinning with neat sketches. (16)

Reg. No. :

--	--	--	--	--	--	--	--	--	--	--	--	--	--	--	--	--	--	--	--

Question Paper Code : 80658

B.E./B.Tech. DEGREE EXAMINATION, NOVEMBER/DECEMBER 2016.

Third Semester

Manufacturing Engineering

ME 6403 — ENGINEERING MATERIALS AND METALLURGY

(Common to Fourth Semester Automobile Engineering, Mechanical and Automation Engineering and Mechanical Engineering)

(Regulations 2013)

Time : Three hours

Maximum : 100 marks

Answer ALL questions.

PART A — (10 × 2 = 20 marks)

1. Define the term solid solutions.
2. How will you classify steels?
3. When will you prefer annealing?
4. Define the term Cementite.
5. List the important properties of HSLA.
6. What are Bronzes? List the uses of Bronzes.
7. Define the term degree of polymerization.
8. State any four applications of Bakelite.
9. Define the term Fatigue.
10. List any four mechanical testing methods of metals.

PART B — (5 × 13 = 65 marks)

11. (a) (i) Explain the various micro constituents present in steel. (8)
(ii) With a neat sketch, label the reactions of Fe-Fe₃C diagram. (5)

Or

- (b) (i) Discuss the classification of cast iron and draw its microstructure. (9)
- (ii) State the properties and applications of plain carbon steel. (4)
- 12. (a) (i) Distinguish between annealing and tempering. (4)
- (ii) Explain in detail the flame and induction hardening with neat sketches. (9)

Or

- (b) Explain the principle and procedure of Jominy end quench test with a diagram. Also sketch the graph hardness Vs distance from quenched end. (13)
- 13. (a) (i) With a neat sketch, explain precipitations hardening. (8)
- (ii) State the compositions, properties and uses of bearing alloys. (5)

Or

- (b) Write short notes on the following :
 - (i) Maraging steels (4)
 - (ii) SS (5)
 - (iii) HSS. (4)
- 14. (a) Explain the following.
 - (i) Engineering ceramics. (5)
 - (ii) Formaldehydes (4)
 - (iii) PMMA. (4)

Or

- (b) (i) Explain the Engineering polymers in detail. (7)
- (ii) State the properties and uses of reinforced composites. (6)
- 15. (a) (i) What are the different hardness tests performed in metallic natural? Specify the indenter and hardness measurement scale of the same. (4)
- (ii) Explain the procedure of tensile test for metals. (9)

Or

- (b) (i) Explain the mechanism of plastic deformation with suitable illustrations. (8)
- (ii) Discuss about the creep test with a typical creep curve. (5)



ST. ANNE'S

COLLEGE OF ENGINEERING AND TECHNOLOGY
ME8491 ENGINEERING METALLURGY

PART C — (1 × 15 = 15 marks)

16. (a) Discuss the effects and characteristics of alloying elements in steel. (15)

Or

- (b) Name the suitable alloys, polymers and ceramics for manufacturing the following items. (15)

- (i) Bush
- (ii) Furnaces heating element
- (iii) Lathe bed
- (iv) Coins
- (v) Girders for Airship
- (vi) Big end bearing
- (vii) Turbine blades
- (viii) Conduit pipes
- (ix) Knobs
- (x) Windshields
- (xi) Touch screens
- (xii) Furnace linings
- (xiii) Grinding (abrasive) wheels
- (xiv) Coatings on cutting inserts
- (xv) Cutting inserts for ferrous alloys.